



XLC-25/40/60-MA

User Manual



Matter wireless dimming LED driver



Content

1. Overview	1
1.1 Overview devices	1
1.2 Device Features	1
1.3 Displays and operating elements	2
1.3.1 Wiring	2
1.3.2 LED Indicator	2
2. Factory Reset	3
2.1 By RESET BUTTON	3
2.2 By AC ON/OFF	3
3. Matter	4
3.1 What is Matter	4
3.2 What is Thread	4
4. How to use Matter	5
4.1 Commissioning using Apple ecosystem	5
4.1.1 Components	5
4.1.2 Step by step	6
4.2 Commissioning using other ecosystems	9
4.2.1 Components	9
4.2.2 Step by step	9
5. Placement considerations	13
6. Warranty	14
7. Environmental declaration information	14

1. Overview

1.1 Overview devices

The manual refers to the following devices that support the Matter standard:

- **XLC-25-H-MA(S)**: INPUT 100 ~ 305VAC 47 ~ 63Hz, OUTPUT: 300mA ~ 1050mA, 9 ~ 54V, 25W
- **XLC-40-H-MA(S)**: INPUT: 100 ~ 305VAC 47 ~ 63Hz, OUTPUT: 600mA ~ 1400mA, 9 ~ 54V, 40W
- **XLC-60-H-MA(S)**: INPUT: 100 ~ 305VAC 47 ~ 63Hz, OUTPUT: 900mA ~ 1700mA, 9 ~ 54V, 60W
- **XLC-60-12-MA(S)**: INPUT: 100 ~ 305VAC 47 ~ 63Hz, OUTPUT: 12V/5A, 60W
- **XLC-60-24-MA(S)**: INPUT: 100 ~ 305VAC 47 ~ 63Hz, OUTPUT: 24V/2.5A, 60W
- **XLC-60-48-MA(S)**: INPUT: 100 ~ 305VAC 47 ~ 63Hz, OUTPUT: 48V/1.25A, 60W

※Note: casing type: S: with strain-relief (Independent type)
Blank: without strain-relief (Built-in type)

1.2 Device Features

The XLC-25/40/60-H-MA(S) Series is a multi-stage constant-power LED driver. The output current range can be adjusted through DIP switches. This series supports Matter wireless dimming technology, reaching a minimum dimming level of 0.5%. The XLC-60-12/24/48-MA(S) Series is a constant voltage LED driver that also supports Matter wireless dimming, permitting a minimum dimming level of 0.1%. All products offer a wide voltage input range of 100-305Vac and can be configured as either built-in or independent types. Communication is based on the Thread network and is certified with Matter, providing you with a simple, reliable, and secure intelligent experience.

1.3 Displays and operating elements

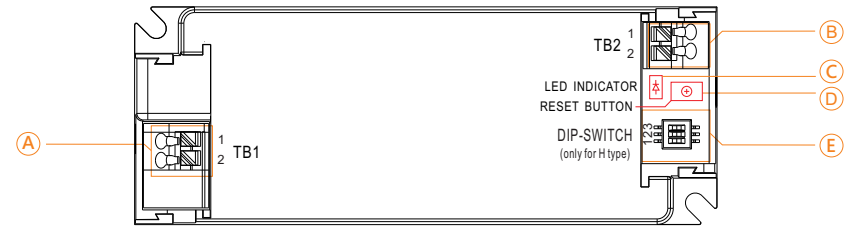

- Ⓐ: AC INPUT
- Ⓑ: DC OUTPUT
- Ⓒ: LED INDICATOR
- Ⓓ: RESET BUTTON
- Ⓔ: DIP-SWITCH (only for H type)

1.3.1 Wiring

TYPE	MODEL	Wire stripping length	Wire TYPE
AC INPUT TB1	XLC-25/40/60-MA	8-9mm	0.5-1.5mm ²
	XLC-25/40/60-MAS		0.75-1.5mm ²
DC OUTPUT TB2	XLC-25/40/60-MA		0.5-1.5mm ²
	XLC-25/40/60-MAS		0.5-1.5mm ²

1.3.2 LED Indicator

Status	Indicator
Flash slowly	Bluetooth Broadcast is running, at which point the pairing operation can be performed.
Flash quickly	Factory Reset is running
Constantly ON	Matter wireless is connected
Constantly OFF	Matter wireless is disconnected and Bluetooth Broadcast is OFF

2.Factory Reset

If the XLC-MA has previously been paired with another device (in a paired state), it can be reset to participate in pairing again by restoring its factory settings. There are two ways to restore factory settings as follows.

2.1 By RESET BUTTON

Press and hold the reset button for 10 seconds. When the LED indicator flashes quickly, release the reset button. After that, the factory reset procedure will be completed.

2.2 By AC ON/OFF

When the power supply is designed inside the luminaire and the reset button is inaccessible, Factory Reset can be performed by toggling the AC ON/OFF. To perform Factory Reset through AC ON/OFF, the following process must be strictly followed. If the AC ON/OFF process is correct, the output light will flash for 15 seconds. When the flashing stops, it means the Factory Reset is completed.

AC ON/OFF process to execute Factory Reset:

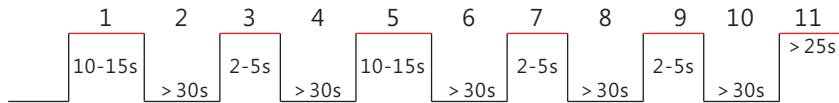

stage	Hold time	AC status
1	10-15s	ON
2	>30s	OFF
3	2-5s	ON
4	>30s	OFF
5	10-15s	ON
6	>30s	OFF
7	2-5s	ON
8	>30s	OFF
9	2-5s	ON
10	>30s	OFF
11	>25s	ON(Wait until the output light stops blinking)

Note: If there is a malfunction in the 'AC ON/OFF' process, it can be reset by the following method and start from stage 1 again.

Method 1: AC ON time exceeds 25 seconds °

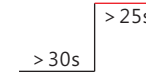

Method 2: Perform two AC on operations, 2 - 5 seconds each °

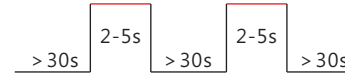

3.Matter

3.1 What is Matter

Matter is a unified smart home standard jointly developed by multiple member companies of the Connectivity Standards Alliance, aiming to ensure seamless interoperability among devices from different brands. Various enterprises have established their ecosystems based on the Matter standard, using their own apps and hub devices to interact with a variety of Matter-compliant devices, thus delivering a comprehensive user experience.

Refer to the official website of the CSA:
<https://csa-iot.org/all-solutions/matter/>

3.2 What is Thread

Thread, based on 6LoWPAN, fully utilizes open standards and IPv6 technology, featuring security and reliability, no single point of failure, ease of connection, and low power consumption. Developers and consumers can easily and securely use Thread to form a low-power wireless mesh network comprising over 250 devices. Within the network, each device can connect to the internet and access cloud services.

Refer to the official website of the Thread Group:
<https://www.threadgroup.org>

*The number of devices managed in a Thread network is influenced by the processing capacity of the hub device and the network topology. In typical application scenarios, it is recommended that the number of devices does not exceed 250 to ensure stability and response speed. However, consult your hub device provider and conduct onsite tests to expand the number of devices.

4.How to use Matter

Matter aims to utilize the existing infrastructure in your home to reduce the complexity of your smart home. Users can easily set up and control devices without fully understanding the architecture of the smart home. The following diagram shows the configuration of the MEANWELL XLC series application system.

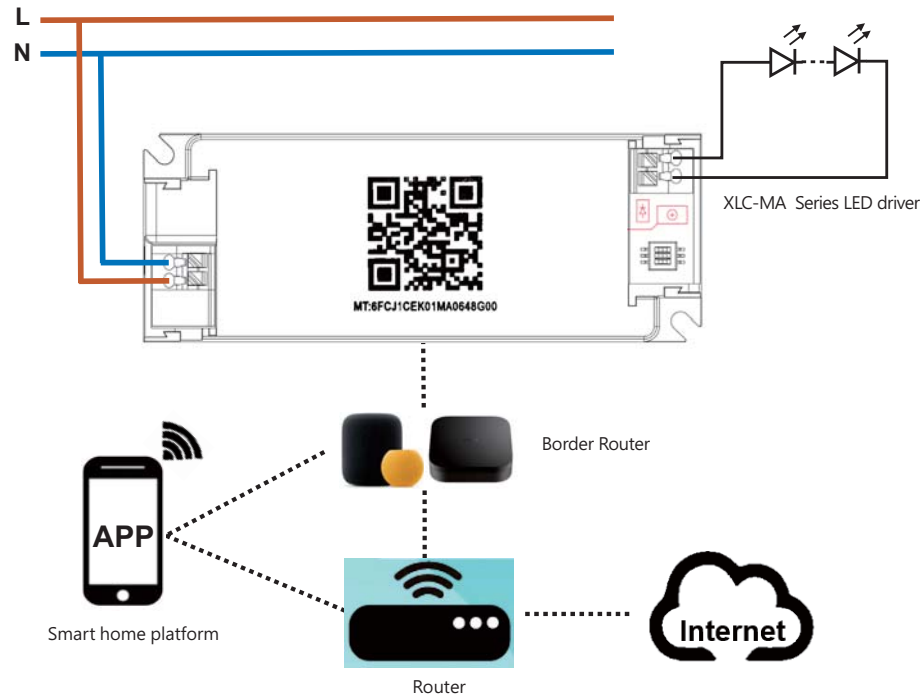

4.1 Commissioning using Apple ecosystem

4.1.1 Components

- Router: Provide stable wireless network
- Border Router: Homepod
- Apple's system devices: The operating system requirement is iOS 16.1 or above. For iPhone 15 Pro, iPhone 15 Pro Max, or newer models running iOS 18, there is no need to use HomePod as the home hub, and they can be directly paired with XLC-MA.
- APP: "Home"

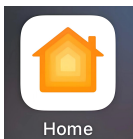

- Matter device: Luminaire powered by XLC-40-H-MA

4.1.2 Step by step

- ① Check whether the router's network connection is stable and reliable.
 - ② Check if your phone is connected to the correct wireless network.
 - ③ Use an iPhone to open the "Home" APP. Tap "Add or Scan Accessories", and then add the HomePod to "My Home" following the APP's operation instructions.
- * For iPhone 15 Pro, iPhone 15 Pro Max, or later models running iOS 18 or later, you can skip this step.

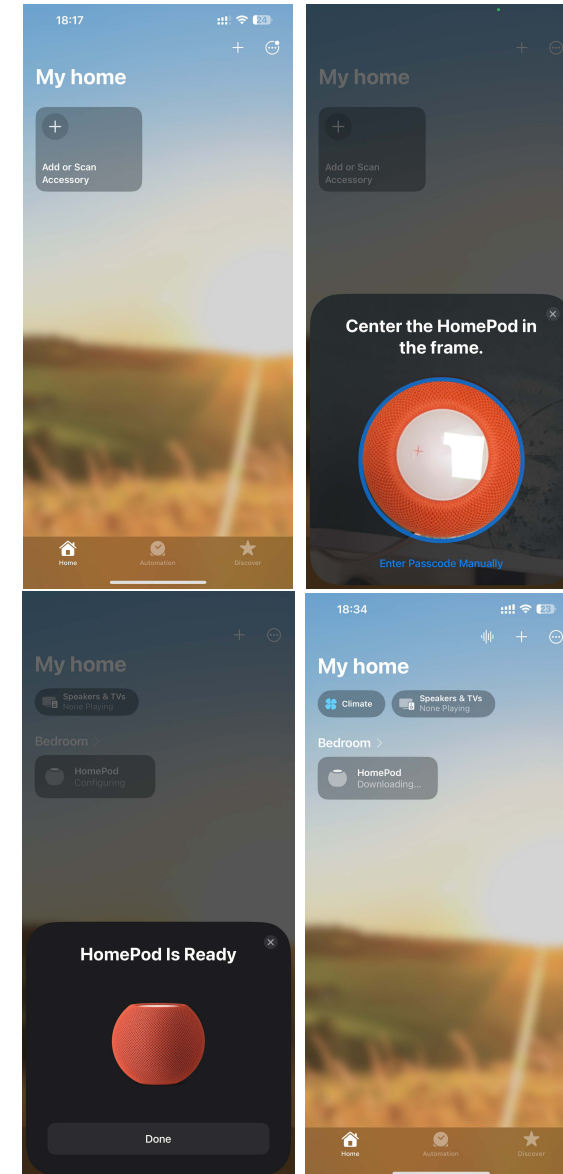

④ Turn on the luminaire powered by XLC-40-H-MA. Confirm that the LED indicator of the XLC-40-H-MA is in a "Flash slowly" state. Then, tap the "+" in the upper - right corner of the APP. Select "Add or Scan Accessory". Scan the QR code on the shell of the XLC-40-H-MA. Follow the operation instructions to add the light. You can customize the location and name of the light.

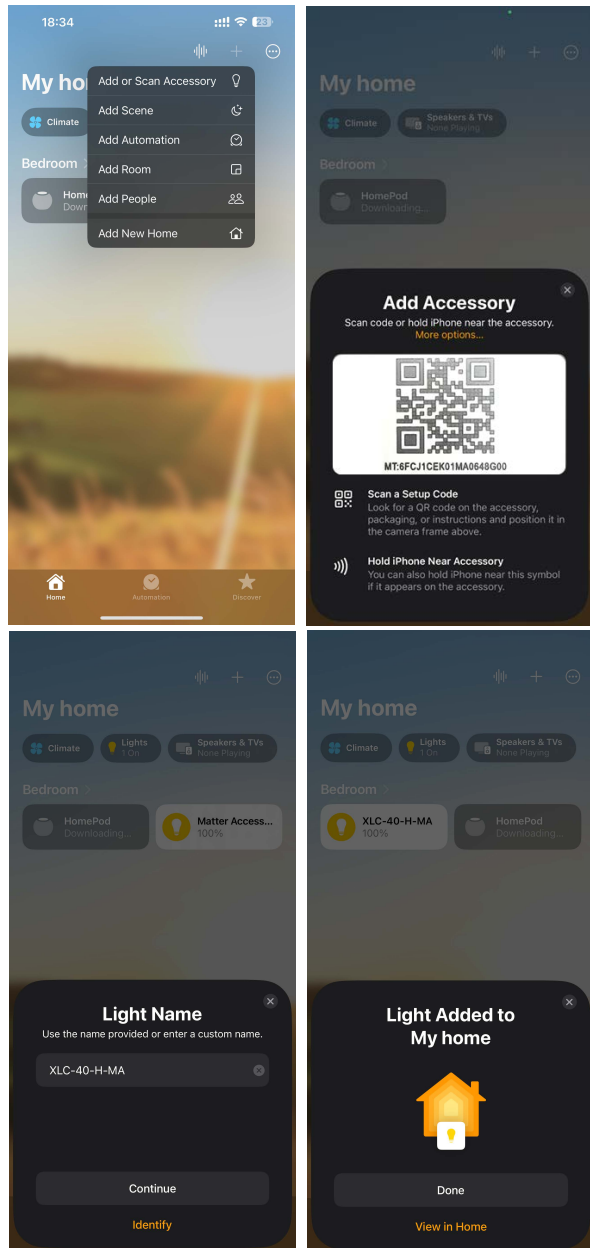

⑤ After adding the light, you can perform operations such as turning it on, turning it off, dimming, creating scenes, setting up timed events, and voice control.

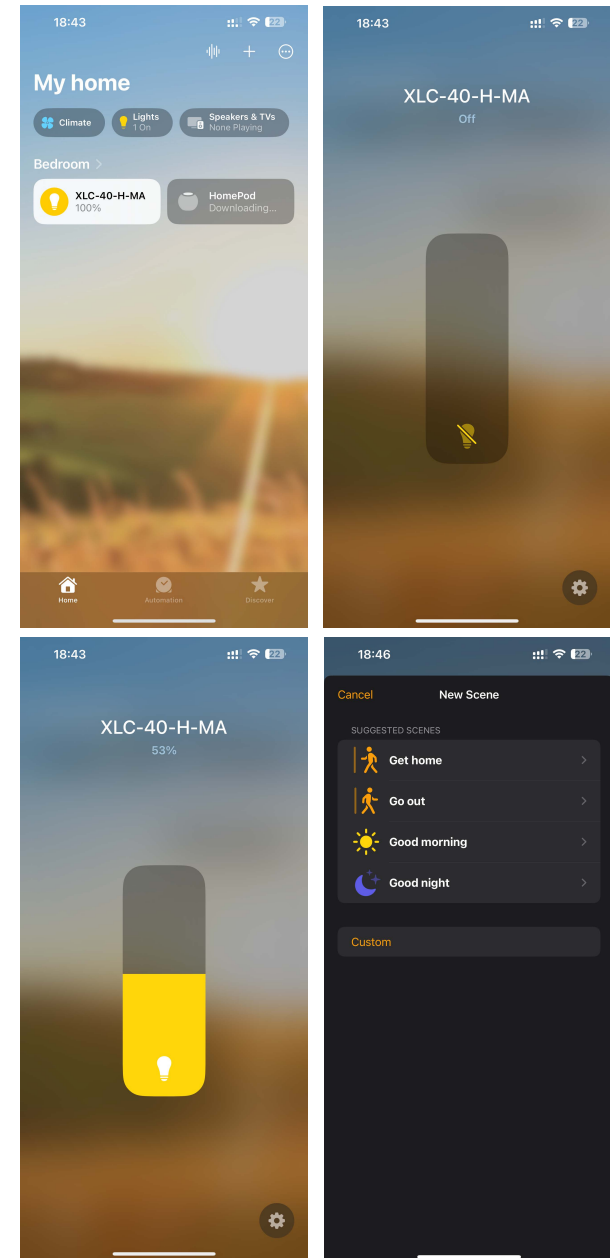

4.2 Commissioning using other ecosystems

Apart from the Apple ecosystem, there are other enterprises that build their own ecosystems based on the Matter standard. Using these enterprises' apps and hub devices, along with other Matter-enabled devices, users can achieve intelligent control of their smart homes. Take "Aqara" as an example for introduction below.

4.2.1 Components

- Router: Provide stable wireless network
- Border Router : "Hub M3"
- Smart devices: devices with Android or iOS operating systems
- APP : download and install the "Aqara Home" APP from the app store



Aqara Home

- Matter device : Luminaire powered by XLC-40-H-MA

4.2.2 Step by Step

- ① Check whether the router's network connection is stable and reliable.
- ② Check if your phone is connected to the correct wireless network.

- ③ Open the "Aqara Home" APP on your mobile phone. Tap the "+" in the upper - right corner, select "Add Accessory", and add the "Hub M3" to "Home". Make sure that the "Hub M3" is connected to the same local area network as your mobile phone.

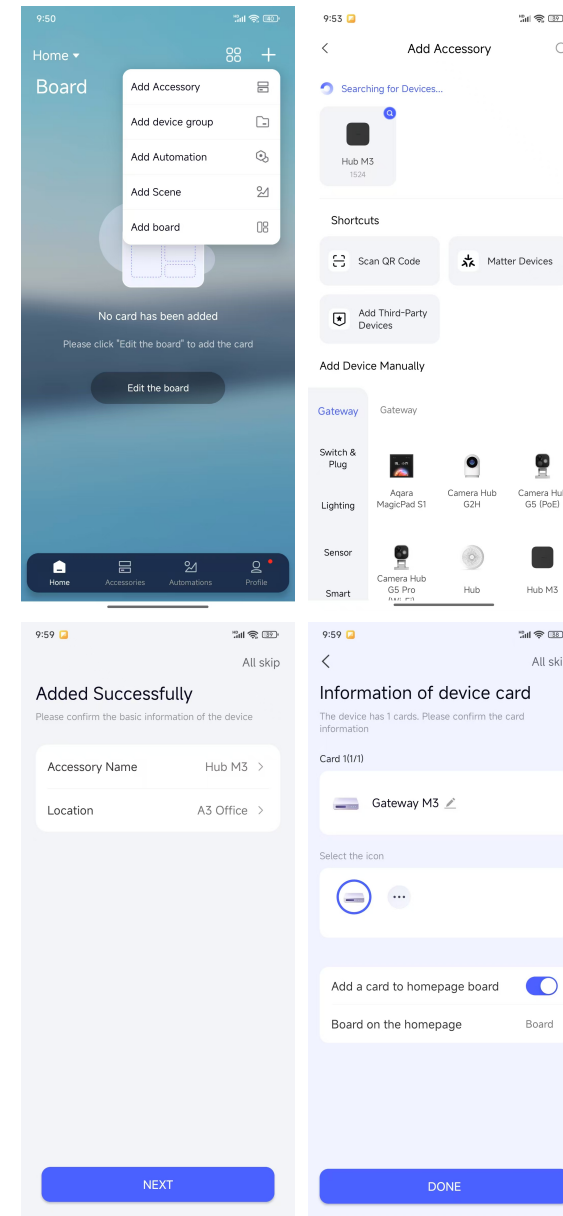

- ④ Turn on the luminaire powered by XLC-40-H-MA. Confirm that the LED indicator of the XLC-40-H-MA is in a "Flash slowly" state. Then, tap the "+" in the upper-right corner of the APP. Select "Add Accessory". Scan the QR code on the shell of the XLC-40-H-MA. Follow the operation instructions to add the light. You can customize the location and name of the light.

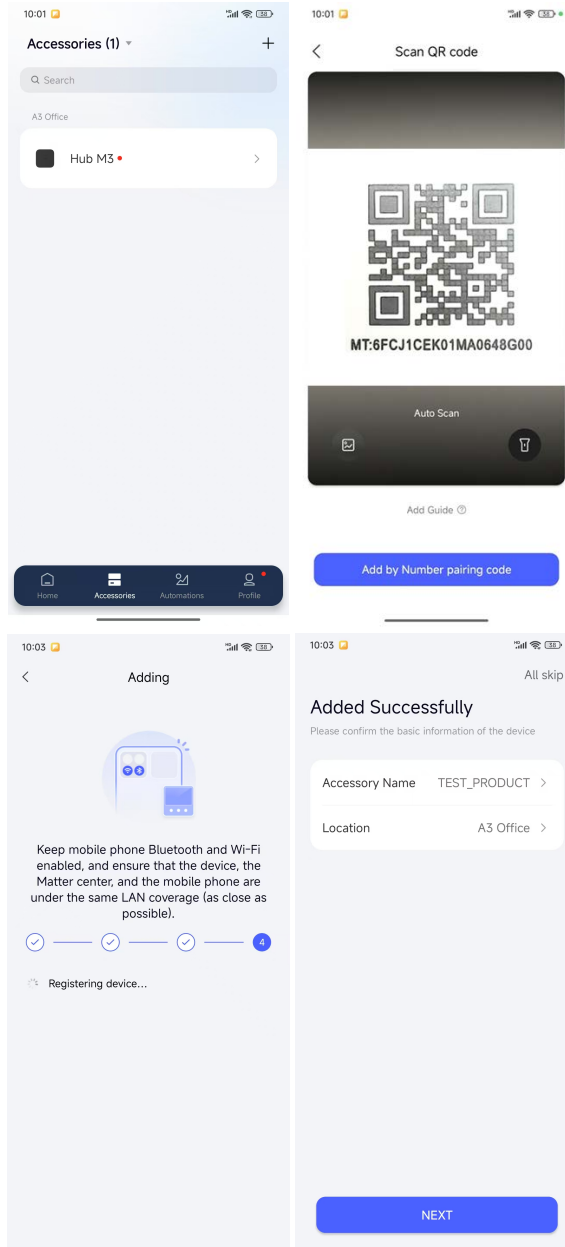

- ⑤ After adding the light, you can turn the light on/off, adjust brightness, create scenes and set timed events.

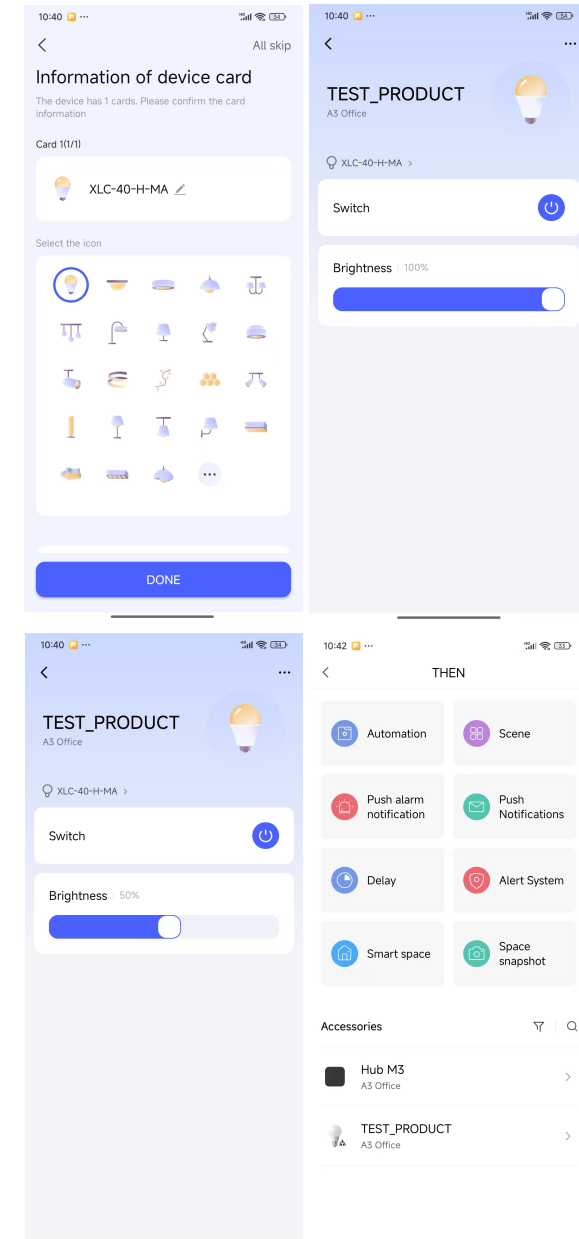

5.Placement considerations

Matter device has an integrated antenna for easy integration. In order to maximize the range in every direction, some design guidelines should be taken into consideration when mounting the device.

The antenna positions of the device are shown in the figure below:

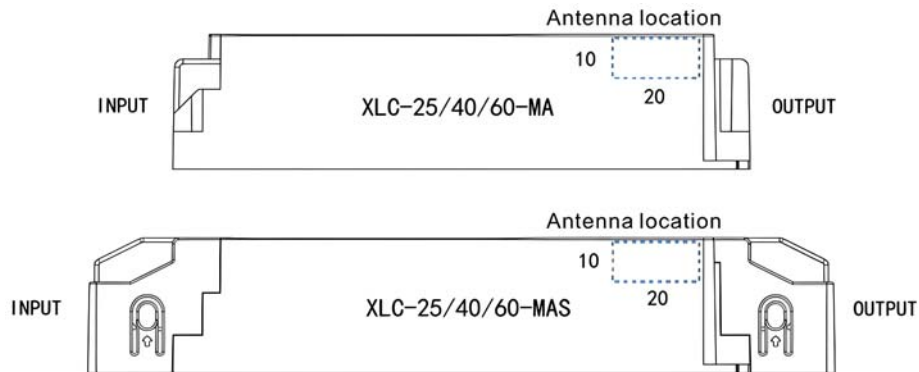

- Keep the device as far away as possible from vertical metal structures
- When the device is mounted on a metal plate, the antenna should not be obscured, and there needs to be a cutout under the antenna to ensure that the RF signal can be transmitted
- The device's communication range may be influenced by environmental factors and installation positioning, necessitating on-site adjustments and testing

6.Warranty

This product provides five years warranty under normal usage. Do not replace parts or any form of modification to the product in order to keep the warranty effectively.

※MEAN WELL possesses the right to adjust the content of this manual.

Please refer to the latest version of our manual on our website.

<https://www.meanwell.com>



7.Environmental declaration information

https://www.meanwell.com//Upload/PDF/RoHS_PFOS.pdf

https://www.meanwell.com//Upload/PDF/REACH_SVHC.pdf

https://www.meanwell.com//Upload/PDF/Declaration_RoHS-E.pdf

明緯企業股份有限公司

MEAN WELL ENTERPRISES CO., LTD.

248 新北市五股區五權三路28號

No.28, Wuquan 3rd Rd., Wugu Dist., New Taipei City 248, Taiwan

Tel:886-2-2299-6100 Fax:886-2-2299-6200

http://www.meanwell.com E-mail:info@meanwell.com