



XLC-25-KN-S Series  
(Independent type)



XLC-25-KN Series  
(Built-in type)



## ■ Features

- Constant power mode output with multiple stage selectable by ETS database
- Plastic housing with class II and PFC design
- Flicker free, complying with CE ErP directive
- Standby power consumption <0.5W
- Meet emergency lighting (EL) application
- KNX/EIB protocol, support KNX data secure
- Minimum dimming level 0.5%
- Function:operation hours,power consumption feedback, log/linear curve selection...etc
- 5 years warranty

## ■ Applications

- Recessed Light
- Down Light
- Panel Light
- Commercial Lighting
- Decorative Lighting
- KNX digital Lighting

## ■ GTIN CODE

MW Search: <https://www.meanwell.com/serviceGTIN.aspx>

## ■ Description

XLC-25-KN Series is a 25W with constant power output LED driver . It can operate from 100~305VAC and output current ranging between 300 mA to 1050 mA selectable by ETS database. The integrated KNX interface avoids using the complicated KNX-DALI gateway.Thanks to high efficiency up to 88%, it is able to operate for -25°C ~85°C case temperature under free air convection. XLC-25-KN is designed based on latest safety regulations, and provides more flexibility for LED Lighting application.

## ■ Model Encoding

XLC - 25 - H - KN □

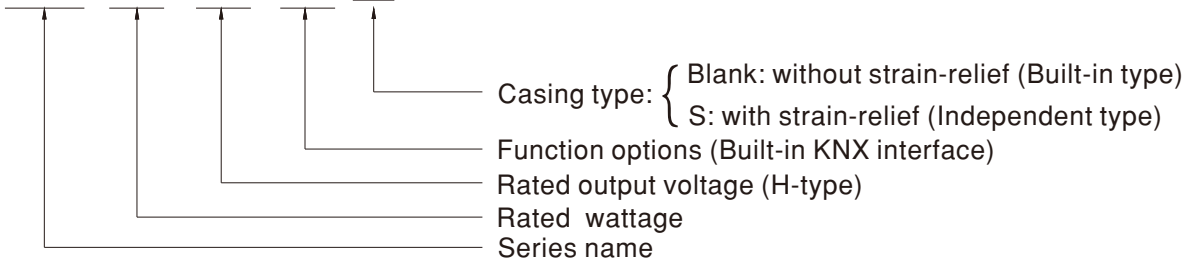

Type	Function	Note
KN	Built-in KNX interface, without strain-relief (Built-in type)	In stock
KNS	Built-in KNX interface, with strain-relief (Independent type)	In stock

**SPECIFICATION**

MODEL		XLC-25-H-KN <input type="checkbox"/>		
OUTPUT	OPEN CIRCUIT VOLTAGE <small>Note.2</small>	60V		
	DEFAULT CURRENT	300mA		
	CURRENT ADJ. RANGE (BY ETS Database)	0.3~1.05A		
	CONSTANT CURRENT REGION <small>Note.3</small>	9~54V		
	RATED POWER <small>Note.4</small>	25W		
	CURRENT RIPPLE	<4%(@full load)		
	CURRENT TOLERANCE	±5%		
	DIMMING RANGE	0~100%		
	SETUP, RISE TIME <small>Note.5</small>	500ms, 100ms/230VAC, 1000ms, 100ms/115VAC		
INPUT	VOLTAGE RANGE	100~ 305VAC 141 ~ 400VDC		
	FREQUENCY RANGE	47 ~ 63Hz		
	POWER FACTOR	PF ≥ 0.97/115VAC, PF ≥ 0.95/230VAC, PF ≥ 0.92/277VAC@full load (Please refer to "POWER FACTOR (PF) CHARACTERISTIC" section)		
	TOTAL HARMONIC DISTORTION	THD<10%(@load ≥ 50%/230VAC; @load ≥ 75%/277VAC), THD<15%(@load ≥ 50%/115VAC) (Please refer to "TOTAL HARMONIC DISTORTION(THD)" section)		
	EFFICIENCY (Typ.) <small>Note.6</small>	88%		
	AC CURRENT	0.35A/ 115VAC 0.18A/ 230VAC 0.15A/277VAC		
	INRUSH CURRENT(Typ.)	COLD START 10A(twidth=100µs measured at 50% Ipeak) at 230VAC; Per NEMA 410		
	MAX. No. of PSUs on 16A CIRCUIT BREAKER	71 units (circuit breaker of type B) / 71 units (circuit breaker of type C) at 230VAC		
	LEAKAGE CURRENT	<0.75mA / 277VAC		
	STANDBY POWER CONSUMPTION <small>Note.7</small>	Standby power consumption<0.5W(Dimming off)		
	PROTECTION	SHORT CIRCUIT	Hiccup mode, recovers automatically after fault condition is removed	
OVER TEMPERATURE		Stage 1: De-rating to 75% loading; Stage 2: De-rating to 50% loading. Recovers automatically after fault condition is removed.		
ENVIRONMENT	WORKING TEMP.	Tcase=-25 ~ 85°C (Please refer to " OUTPUT LOAD vs TEMPERATURE" section)		
	MAX. CASE TEMP.	Tcase=85°C		
	WORKING HUMIDITY	20 ~ 90% RH non-condensing		
	STORAGE TEMP., HUMIDITY	-40 ~ +80°C, 10 ~ 95% RH		
	TEMP. COEFFICIENT	±0.03%/°C (0 ~ 50°C)		
	VIBRATION	10 ~ 500Hz, 2G 10min./1cycle, period for 60min. each along X, Y, Z axes		
SAFETY & EMC	SAFETY STANDARDS	ENEC BS EN/EN61347-1, BS EN/EN61347-2-13(EL) appendix J suitable for emergency installations(DC input 176-280VDC), BS EN/EN62384; GB/T19510.1, GB/T19510.213, EAC TP TC 004 approved; Design refer to AS/NZS 61347-1, AS/NZS 61347-2-13		
	WITHSTAND VOLTAGE	I/P-O/P:3.75KVAC		
	ISOLATION RESISTANCE	I/P-O/P:>100M Ohms / 500VDC / 25°C / 70% RH		
	EMC EMISSION	Parameter	Standard	Test Level/Note
		Conducted	BS EN/EN55015(CISPR15) ,GB/T 17743	-----
		Radiated	BS EN/EN55015(CISPR15) ,GB/T 17743	-----
		Harmonic Current	BS EN/EN61000-3-2 , GB17625.1	Class C @load≥50%
		Voltage Flicker	BS EN/EN61000-3-3	-----
	EMC IMMUNITY	Parameter	Standard	Test Level/Note
		ESD	BS EN/EN61000-4-2	Level 3, 8KV air ; Level 2, 4KV contact
Radiated		BS EN/EN61000-4-3	Level 2	
EFT/Burst		BS EN/EN61000-4-4	Level 2	
Surge		BS EN/EN61000-4-5	Level3, 1KV/Line-Line	
Conducted		BS EN/EN61000-4-6	Level 2	
Magnetic Field		BS EN/EN61000-4-8	Level 2	
Voltage Dips and Interruptions	BS EN/EN61000-4-11	70% residual voltage for 10 period, 0% residual voltage for 0.5 periods		
OTHERS	KNX	Certified protocol		
	FLICKER <small>Note.8</small>	PstLM ≤ 1, SVM ≤ 0.4		
	MTBF	3949.8 K hrs min. Telcordia SR-332 (Bellcore); 338.5 Khrs min. MIL-HDBK-217F (25°C)		
	DIMENSION	147*40*32mm,107*40*32mm (L*W*H)		
	PACKING	141.6g; 60pcs/9.5Kg/0.58CUFT(for blank type); 160g; 50pcs/9Kg/0.57CUFT(for S-type)		
NOTE	<p>1. All parameters NOT specially mentioned are measured at 230VAC input, rated current and 25°C of ambient temperature.</p> <p>2. Output hiccups under no-load condition.</p> <p>3. Please refer to "DRIVER METHODS OF LED MODULE".</p> <p>4. De-rating may be need under low input voltages. Please refer to "STATIC CHARACTERISTIC" sections for details.</p> <p>5. Length of set up time is measured at first cold start. Turning ON/OFF the driver may lead to increase of the set up time.</p> <p>6. Efficiency is measured at 500mA/50V output set by ETS database.</p> <p>7. Standby power consumption is measured at 230VAC.</p> <p>8. Flicker is measured at full load with LED modules.</p> <p>9. The driver is considered as a component that will be operated in combination with final equipment. Since EMC performance will be affected by the complete installation, the final equipment manufacturers must re-qualify EMC Directive on the complete installation again. (as available on <a href="https://www.meanwell.com/Upload/PDF/EMI_statement_en.pdf">https://www.meanwell.com/Upload/PDF/EMI_statement_en.pdf</a>)</p> <p>10. For XLC(except -S) series: RCM is on a voluntary basis and meets relevant IEC or AS/NZS standards complying with AS/NZS 4417.1. For XLC-S series: RCM is on a voluntary basis. Non IC classification Independent LED control gear is not suitable for residential installations.</p> <p>11.This series meets the typical life expectancy of &gt;50,000 hours of operation when Tcase, particularly (C) point (or TMP, per DLC), is about 70°C or less.</p> <p>12. The ambient temperature de-rating of 3.5°C/1000m with fanless models and 5°C/1000m with fan models for operating altitude higher than 2000m(6500ft).</p> <p>13. For more information, please contact with MEAN WELL sales.</p> <p>※Product Liability Disclaimer: For detailed information, please refer to <a href="https://www.meanwell.com/serviceDisclaimer.aspx">https://www.meanwell.com/serviceDisclaimer.aspx</a></p>			

**BLOCK DIAGRAM**

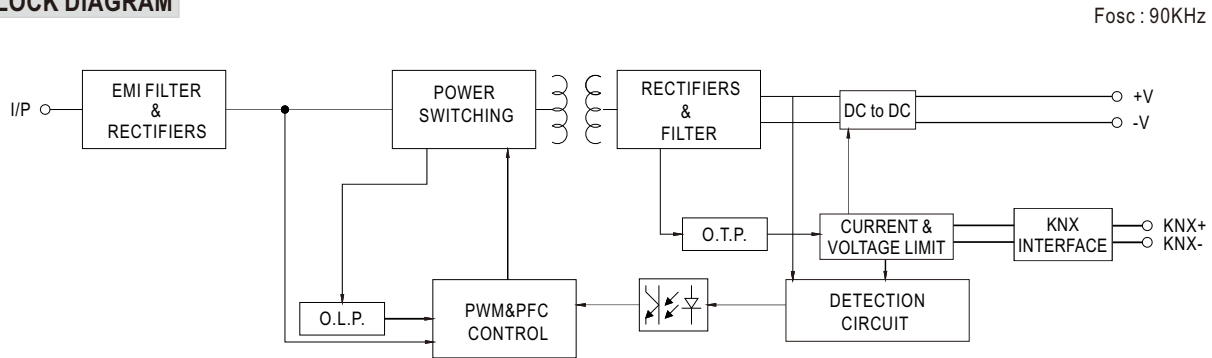

**DRIVING METHODS OF LED MODULE**

※ I-V Operating Area

◎ XLC-25-H-KN

For 25W application

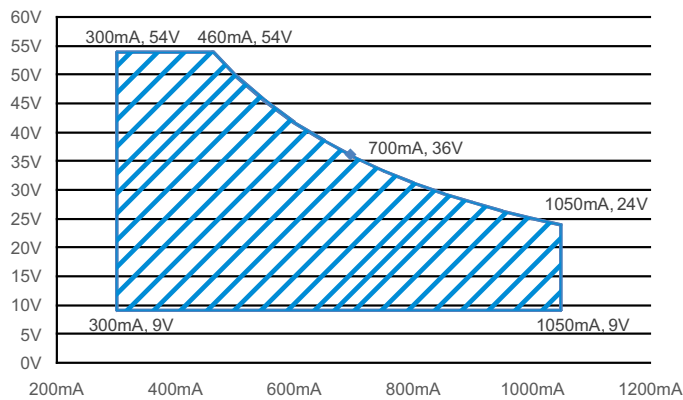

**CONSTANT POWER TABLE**

XLC-25-KN is a multiple-stage constant power driver, selection of output current through Database.

Vo	Io	Vo	Io
9~54V	300mA(Default)	9~36V	700mA
9~54V	350mA	9~33V	750mA
9~54V	400mA	9~31V	800mA
9~50V	450mA	9~29V	850mA
9~50V	500mA	9~28V	900mA
9~45V	550mA	9~26V	950mA
9~42V	600mA	9~25V	1000mA
9~38V	650mA	9~24V	1050mA

**■ DIMMING OPERATION**

※ **KNX interface**

- Apply KNX Bus cable between KNX+ and KNX-
- The application program(database) can be downloaded via Online Catalogs from ETS or via <http://www.meanwell.com/productCatalog.aspx>

Parametrization options	Description
Device Setting	<ul style="list-style-type: none"> <li>• Select current level</li> <li>• Select model</li> <li>• Behavior bus power up</li> </ul>
Parameter Setting	<ul style="list-style-type: none"> <li>• Basic Setting                             <ul style="list-style-type: none"> <li>• normal Dimmer, staircase light</li> <li>• switch function</li> <li>• relative dimming function</li> <li>• absolute dimming function</li> </ul> </li> <li>• Feedback Setting                             <ul style="list-style-type: none"> <li>• dimming value report</li> <li>• on/off state report</li> <li>• lamp failure report</li> </ul> </li> <li>• Lock function</li> </ul>
Scenes	<ul style="list-style-type: none"> <li>• Learn scene</li> <li>• scene1~scene32</li> </ul>
Automatic function	<ul style="list-style-type: none"> <li>• Automatic function1~4</li> </ul>
operating hours	<ul style="list-style-type: none"> <li>• Counting of operating hours</li> <li>• Constant light output(CLO)</li> <li>• Life time pre-warning</li> </ul>
Power consumption	<ul style="list-style-type: none"> <li>• Voltage, current, power feedback</li> <li>• Energy consumption feedback</li> </ul>
Temperature Measurement	<ul style="list-style-type: none"> <li>• customize the alarm temperature</li> <li>• Send temperature report cyclically</li> </ul>
Auto-dimming over time	<ul style="list-style-type: none"> <li>• Optional gradient dimming</li> </ul>
Correction characteristic	<ul style="list-style-type: none"> <li>• Correction by lux measured value(lux)</li> </ul>
Push Dim Port	<ul style="list-style-type: none"> <li>• Push dim</li> <li>• AC monitor</li> </ul>

※ **CONSTANT LIGHT OUTPUT**

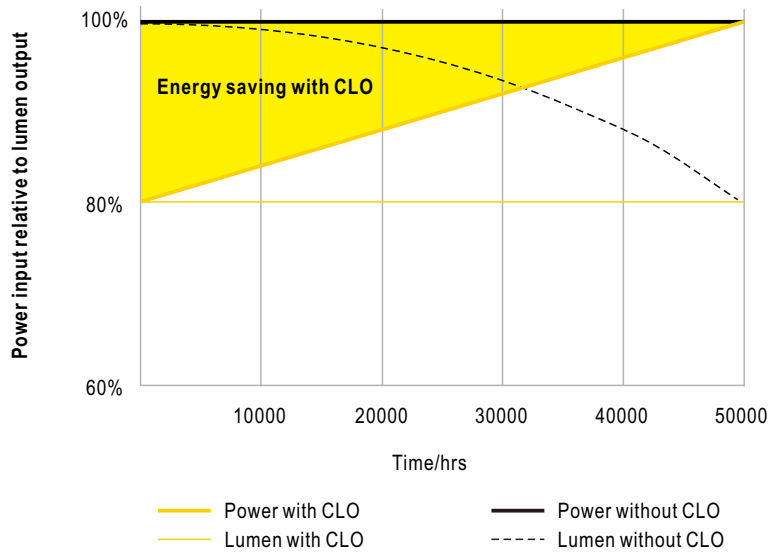

※ **PUSH dimming or AC/DC input monitor(Primary side)**

◎ **PUSH dimming**

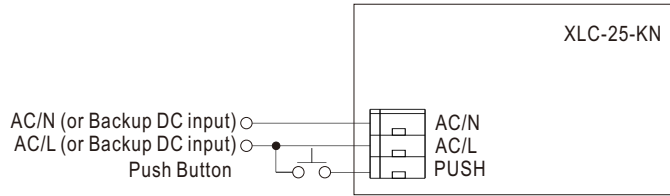

- KNX bus need to be connected when using PUSH Dimming
- The detailed function of PUSH dimming, please refer to the database.
- The maximum length of the cable between the push button and driver is 20 meters.
- The mechanical push button can be connected only between the PUSH terminal, as displayed in the diagram, and AC/L (in brown or black); It will not function properly if it is connected to AC/N.
- In case the PUSH dimming is set locally, up to 10 drivers can perform the PUSH dimming at the same time when utilizing one common push button.
- In case the PUSH dimming is set independently via ETS, the number of drivers is done through group address and determined by the ETS project designer.

◎ **AC/DC input monitor**

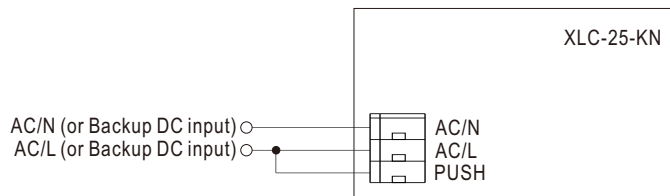

- KNX bus need to be connected when using AC/DC input monitor
- The detailed function of AC/DC input monitor(emergency lighting), please refer to the database and instruction manual.

**OUTPUT LOAD vs TEMPERATURE**

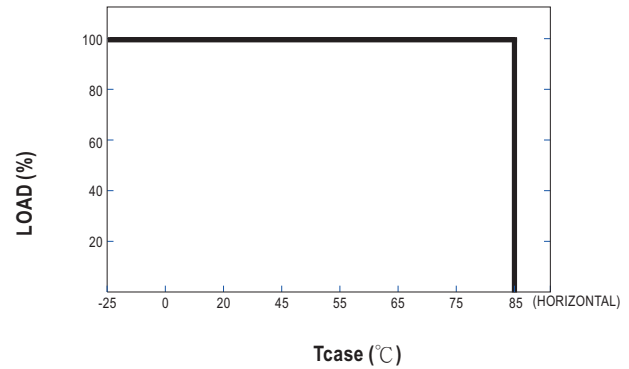
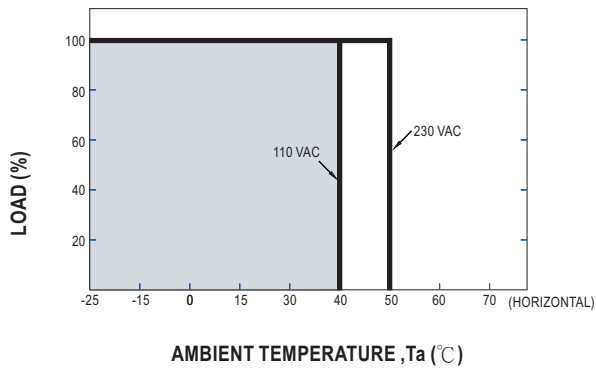

**STATIC CHARACTERISTIC**

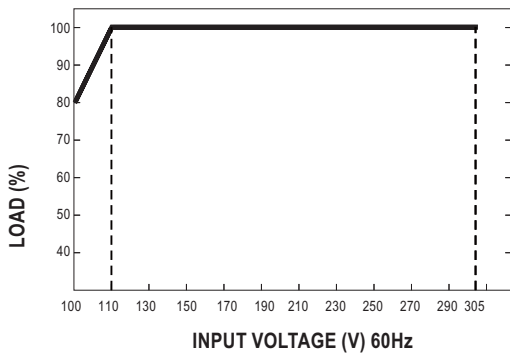

※ De-rating is needed under low input voltage.

**LIFE TIME**

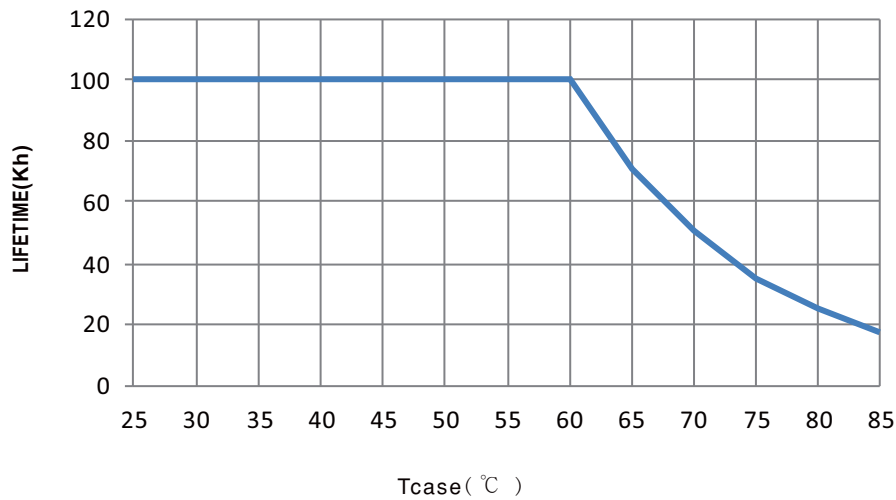

**TOTAL HARMONIC DISTORTION (THD)**

※ XLC-25-H-KN, Tcase at 75°C

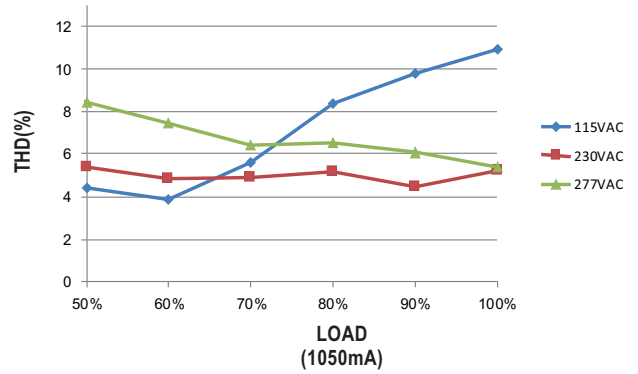
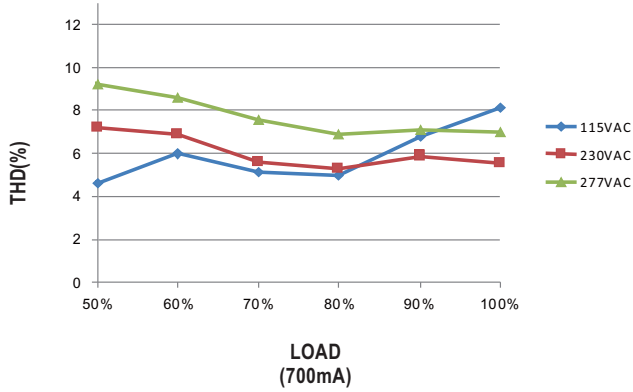

**POWER FACTOR (PF) CHARACTERISTIC**

※ XLC-25-H-KN, Tcase at 75°C

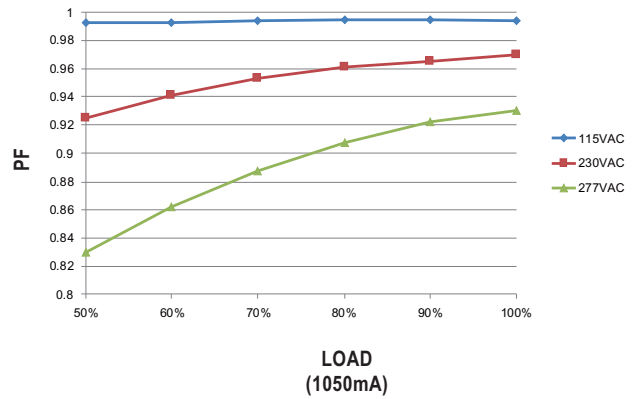
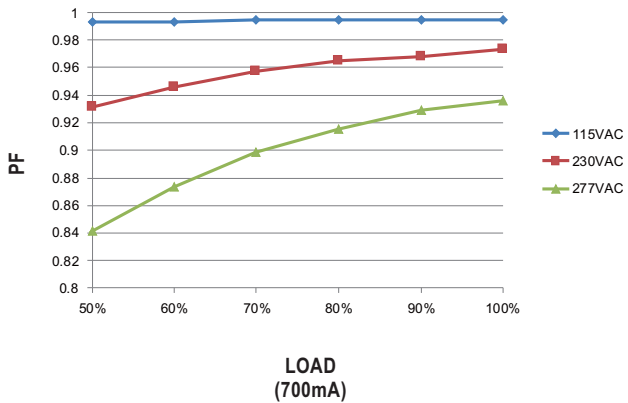

**EFFICIENCY vs LOAD**

XLC-25-KN series possess superior working efficiency that up to 88% can be reached in field applications.

※ XLC-25-H-KN, Tcase at 75°C

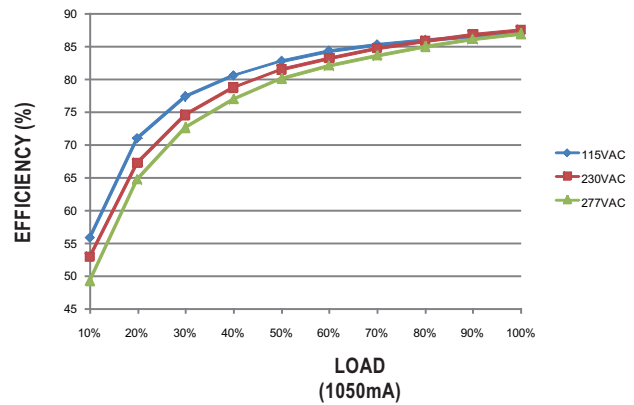
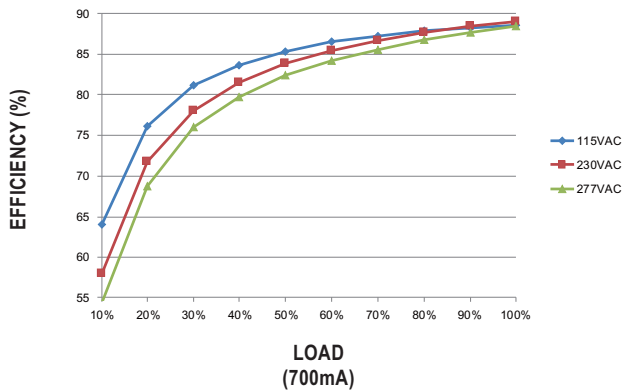

## MECHANICAL SPECIFICATION

Case No. XLC-25 Unit:mm Tolerance:±1

※ XLC-25-KN Built-in Type

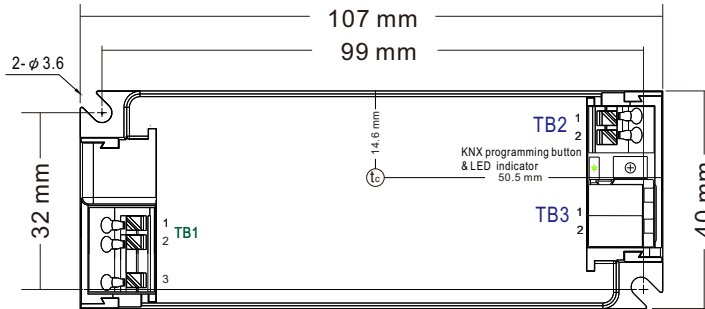

※ Terminal Pin No. Assignment (TB1)

Pin No.	Assignment
1	AC/N
2	AC/L
3	PUSH

※ Terminal Pin No. Assignment (TB2)

Pin No.	Assignment
1	+V
2	-V

※ Terminal Pin No. Assignment (TB3)

Pin No.	Assignment
1	KNX+
2	KNX-

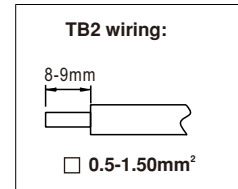
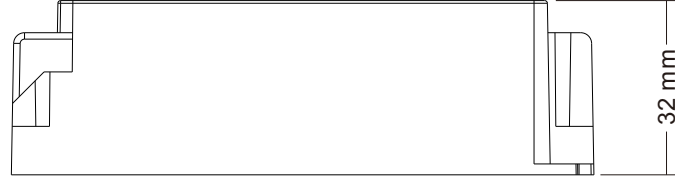
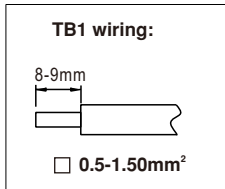

Item	Order No.	Quantity(MOQ/1Bag)
Strain-relief cap	1**3XLC-SET	50pcs (2pcs 1 set)

※ XLC-25-H-KNS Independent Type

Case No. XLC-25-S Unit:mm Tolerance:±1

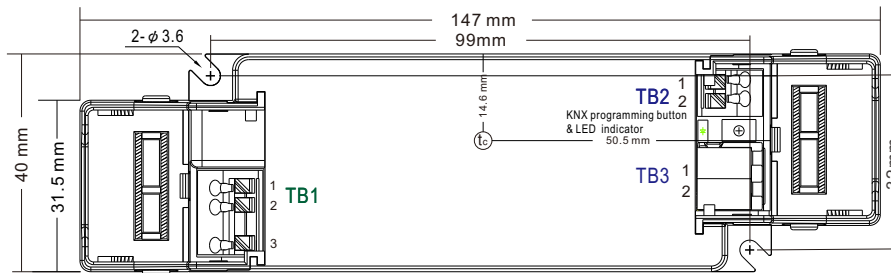

※ Terminal Pin No. Assignment (TB1)

Pin No.	Assignment
1	AC/N
2	AC/L
3	PUSH

※ Terminal Pin No. Assignment (TB2)

Pin No.	Assignment
1	+V
2	-V

※ Terminal Pin No. Assignment (TB3)

Pin No.	Assignment
1	KNX+
2	KNX-

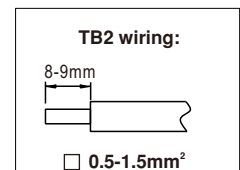
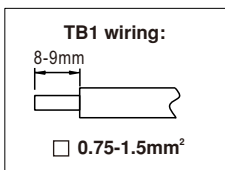

## Installation Manual

Please refer to : <http://www.meanwell.com/manual.html>