

ANSI/AAMI ES60601-1 BS EN/EN60601-1 IEC60601-1 TPTC004



## Features

- 4"x2" compact size
- Medical safety approved (2 x MOPP) according to ANSI/AAMI ES60601-1 and IEC/BS EN/EN60601-1
- Suitable for BF application with appropriate system consideration
- 140W convention, 200W force air
- EMI Conduction for Class B Radiation for Class B with FG(Class I) and Class A without FG(Class II)
- No load power consumption < 0.5W
- Extremely low leakage current
- 12V/0.5A fan supply
- Protections: Short circuit / Overload / Over voltage / Over temperature
- Lifetime > 65K hours
- Operating altitude up to 5000 meters
- 3 years warranty

## Description

RPS-200 is a 200W highly reliable green PCB type medical power supply with a high power density (21.9W/in<sup>3</sup>) on the 4" by 2" footprint. It accepts 80~264VAC input and offers various output voltages between 12V and 48V. The working efficiency is up to 95% and the extremely low no load power consumption is down below 0.5W. RPS-200 is able to be used for both Class I (with FG) and Class II (no FG) system design. The extremely low leakage current is less than 180 μA. In addition, it conforms to the international medical regulations (2\*MOPP) and EMC BS EN/EN55011, perfectly fitting all kinds of BF rated "patient contact" medical system equipment.

## Model Encoding

**RPS - 200 - 12 - C**

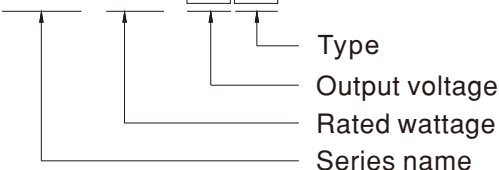

## Applications

## Applications

- Oral irrigator
- Hemodialysis machine
- Medical monitors
- Sleep apnea devices
- Pumps machine
- Electric bed

## GTIN CODE

MW Search: <https://www.meanwell.com/serviceGTIN.aspx>

Type	Description	Note
Blank	PCB Type	In stock
C	Enclosed casing Type	In stock

SPECIFICATION

MODEL		RPS-200-12□	RPS-200-15□	RPS-200-24□	RPS-200-27□	RPS-200-48□	
OUTPUT	DC VOLTAGE	12V	15V	24V	27V	48V	
	CURRENT	10CFM	16.7A	13.4A	8.4A	7.5A	4.2A
		Convection	11.7A	9.4A	5.9A	5.3A	3A
	RATED POWER	10CFM	200.4W	201W	201.6W	202.5W	201.6W
		Convection	140.4W	141W	141.6W	143.1W	144W
	RIPPLE & NOISE (max.) Note.2	100mVp-p	100mVp-p	120mVp-p	120mVp-p	120mVp-p	
	VOLTAGE ADJ. RANGE	11.4~12.6V	14.3~15.8V	22.8~25.2V	25.6 ~ 28.4V	45.6 ~50.4V	
	VOLTAGE TOLERANCE Note.3	±2.0%	±2.0%	±1.0%	±1.0%	±1.0%	
	LINE REGULATION	±0.5%	±0.5%	±0.5%	±0.5%	±0.5%	
	LOAD REGULATION	±1.0%	±1.0%	±1.0%	±1.0%	±1.0%	
SETUP, RISE TIME	700ms, 30ms/230VAC      700ms, 30ms/115VAC at full load						
HOLD UP TIME (Typ.)	16ms/230VAC      16ms/115VAC at full load						
INPUT	VOLTAGE RANGE Note.4	80 ~ 264VAC      113 ~ 370VDC					
	FREQUENCY RANGE	47 ~ 63Hz					
	POWER FACTOR	PF>0.94/230VAC PF>0.98/115VAC at full load					
	EFFICIENCY (Typ.)	93%	93.5%	94%	94%	95%	
	AC CURRENT (Typ.)	2A/115VAC      1A/230VAC					
	INRUSH CURRENT (Typ.)	COLD START 30A/115VAC      60A/230VAC					
	LEAKAGE CURRENT(max.)Note.5	Earth leakage current < 180µA/264VAC , Touch current < 40µA/264VAC					
PROTECTION	OVERLOAD	110 ~ 140% rated output power Protection type : Hiccup mode, recovers automatically after fault condition is removed					
	OVER VOLTAGE	13.2 ~ 15.6V	16.5 ~ 19.5V	26.4 ~ 31.2V	29.7 ~ 35V	52.8 ~ 62.4V	
	OVER TEMPERATURE	Protection type : Shut down o/p voltage, re-power on to recover					
FUNCTION	FAN SUPPLY	12V@0.5A for driving a fan ; tolerance +15% ~ -15% at main output 20% rated current (10CFM)					
ENVIRONMENT	WORKING TEMP.	-30 ~ +70°C (Refer to "Derating Curve")					
	WORKING HUMIDITY	20 ~ 90% RH non-condensing					
	STORAGE TEMP., HUMIDITY	-40 ~ +85°C, 10 ~ 95% RH non-condensing					
	TEMP. COEFFICIENT	±0.03%/°C (0 ~ 50°C)					
	VIBRATION	10 ~ 500Hz, 2G 10min./1cycle, 60min. each along X, Y, Z axes					
	OPERATING ALTITUDE Note.6	5000 meters					
SAFETY & EMC (Note 7)	SAFETY STANDARDS	IEC 60601-1:2005+A1+A2, TUV BS EN/ EN 60601-1:2006+A1+A12+A2, ANSI/AAMI ES60601-1:2005+A2 CAN/CSA C22.2 No. 60601-1:2014+A2, EAC TP TC 004 approved; Design refer to BS EN/EN60335-1(by request)					
	ISOLATION RESISTANCE	Primary-Secondary: 2xMOPP, Primary-Earth:1xMOPP, Secondary-Earth:1xMOPP					
	WITHSTAND VOLTAGE	I/P-O/P:4KVAC    I/P-FG:2KVAC    O/P-FG:1.5KVAC					
	ISOLATION RESISTANCE	I/P-O/P, I/P-FG:100M Ohms / 500VDC / 25°C / 70% RH					
	EMC EMISSION	Parameter	Standard			Test Level / Note	
		Conducted emission	BS EN/EN55011 (CISPR11)			Class B	
		Radiated emission	BS EN/EN55011 (CISPR11)			Class A (for Class II);Class B (for Class I)	
		Harmonic current	BS EN/EN61000-3-2			Class A	
		Voltage flicker	BS EN/EN61000-3-3			-----	
	EMC IMMUNITY	BS EN/EN55035, BS EN/EN60601-1-2					
		Parameter	Standard			Test Level / Note	
		ESD	BS EN/EN61000-4-2			Level 4, 15KV air ; Level 4, 8KV contact	
		RF field susceptibility	BS EN/EN61000-4-3			Level 3, 10V/m( 80MHz~2.7GHz ) Table 9, 9~28V/m( 385MHz~5.78GHz )	
EFT bursts		BS EN/EN61000-4-4			Level 3, 2KV		
Surge susceptibility		BS EN/EN61000-4-5			Level 4, 4KV/Line-FG ; 2KV/Line-Line		
Conducted susceptibility		BS EN/EN61000-4-6			Level 3, 10V		
Magnetic field immunity		BS EN/EN61000-4-8			Level 4, 30A/m		
Voltage dip, interruption	BS EN/EN61000-4-11			100% dip 1 periods, 30% dip 25 periods, 100% interruptions 250 periods			
OTHERS	MTBF	2669.7K hrs min.    Telcordia SR-332 (Bellcore) ; 500.3K hrs min.    MIL-HDBK-217F (25°C)					
	DIMENSION (L*W*H)	PCB:101.6*50.8*29mm or 4"*2"*1.14"inch ; Enclosed type:103.4*62*40mm or 4.07"*2.44"*1.57"inch					
	PACKING	PCB:0.19Kg; 72pcs/14.7Kg/0.84CUFT ; Enclosed type:0.3Kg; 60pcs/19Kg/1.06CUFT					
NOTE	<p>1. All parameters NOT specially mentioned are measured at 230VAC input, rated load and 25 of ambient temperature.</p> <p>2. Ripple &amp; noise are measured at 20MHz of bandwidth by using a 12" twisted pair-wire terminated with a 0.1 µ F &amp; 47 µ F parallel capacitor.</p> <p>3. Tolerance : includes set up tolerance, line regulation and load regulation.</p> <p>4. Derating may be needed under low input voltages. Please check the derating curve for more details.</p> <p>5. Touch current was measured from primary input to DC output.</p> <p>6. The ambient temperature derating of 3.5°C/1000m with fanless models and of 5°C/1000m with fan models for operating altitude higher than 2000m(6500ft).</p> <p>7. The power supply is considered a component which will be installed into a final equipment. All the EMC tests are been executed by mounting the unit on a 360mm*360mm metal plate with 1mm of thickness. The final equipment must be re-confirmed that it still meets EMC directives. For guidance on how to perform these EMC tests, please refer to "EMI testing of component power supplies." (as available on <a href="https://www.meanwell.com/Upload/PDF/EMI_statement_en.pdf">https://www.meanwell.com/Upload/PDF/EMI_statement_en.pdf</a> )</p> <p>※ Product Liability Disclaimer : For detailed information, please refer to <a href="https://www.meanwell.com/serviceDisclaimer.aspx">https://www.meanwell.com/serviceDisclaimer.aspx</a></p>						

### Block Diagram

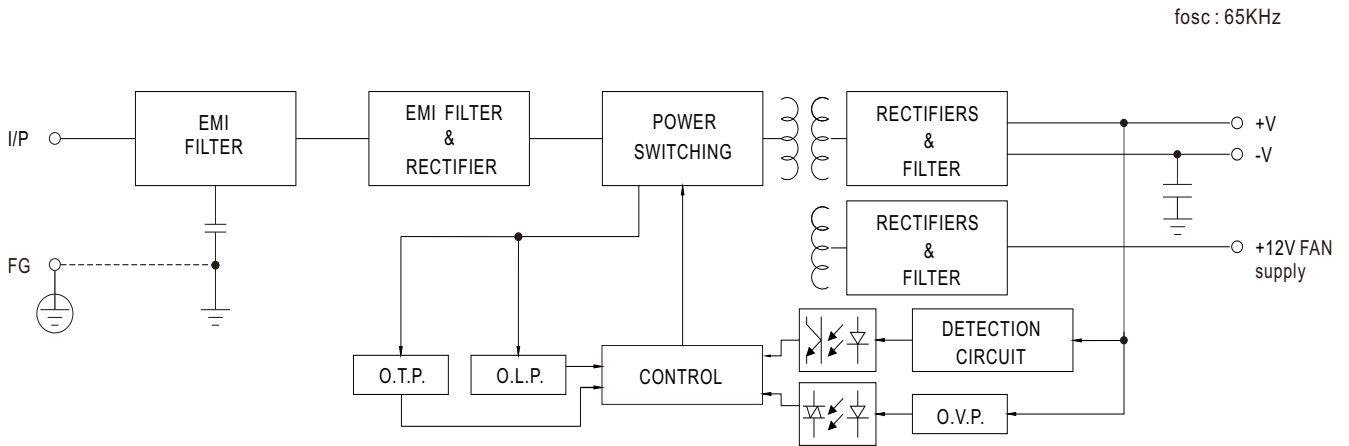

### Derating Curve

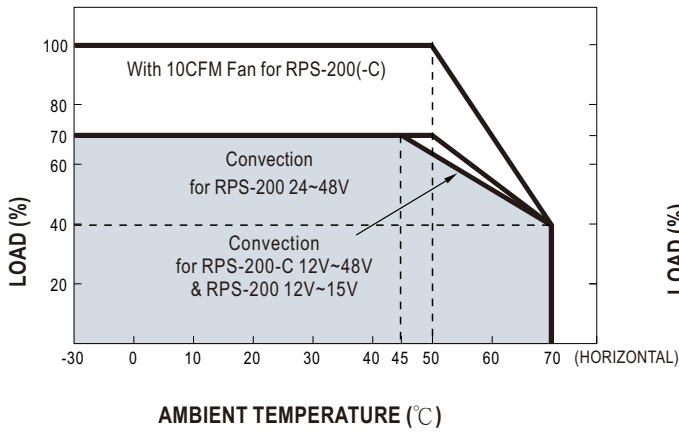

### Output Derating VS Input Voltage

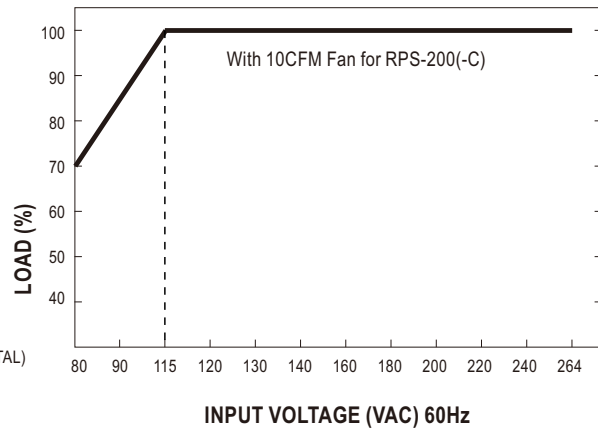

■ Mechanical Specification

(Unit: mm , tolerance  $\pm 1$ mm)

● RPS-200 (PCB Type)

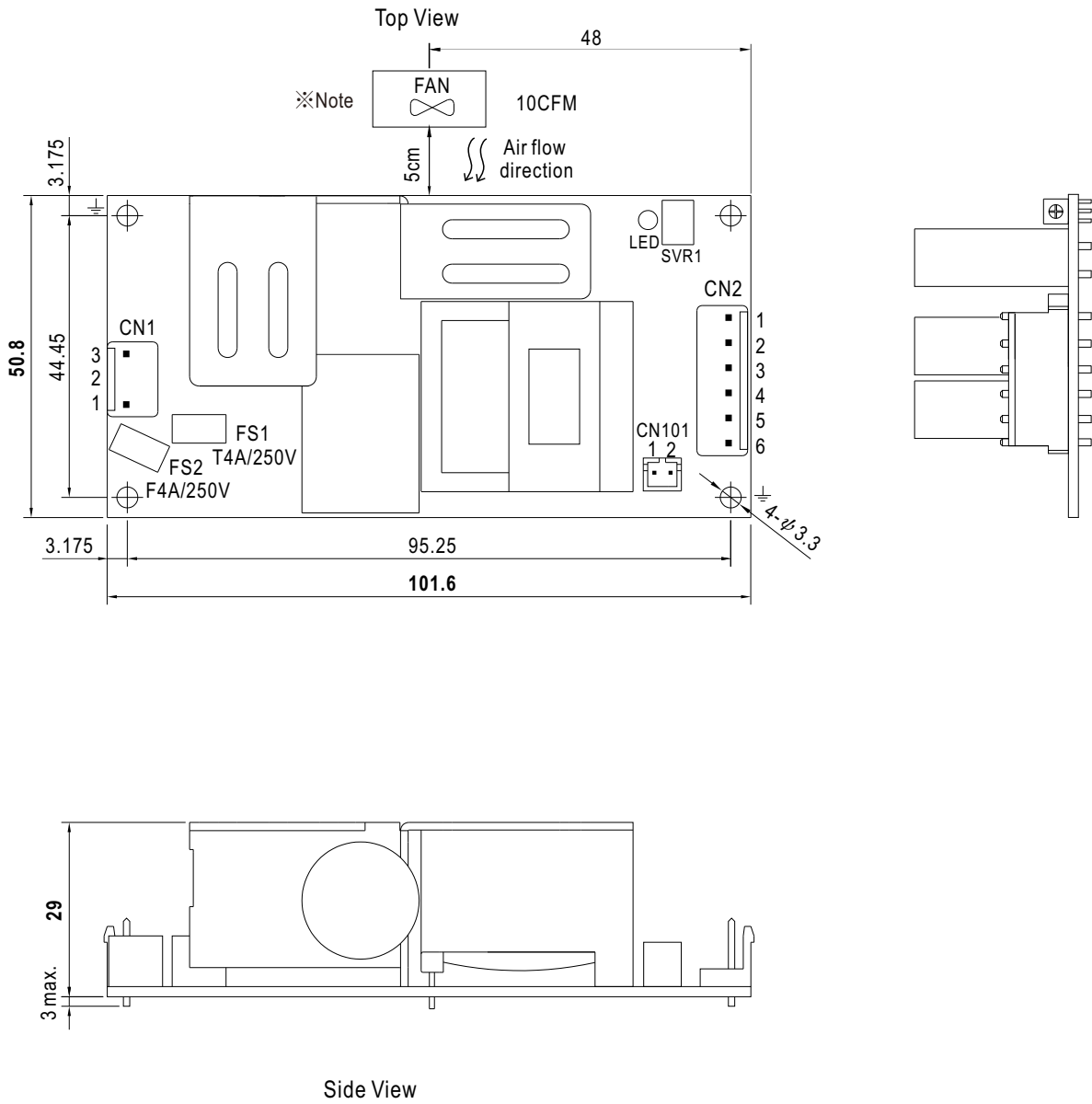

● RPS-200-C (Enclosed Type)

Case No.245A

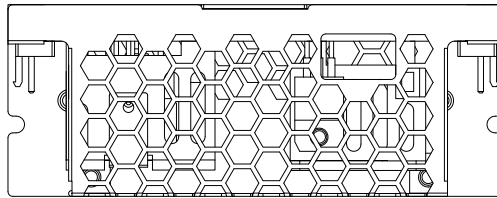
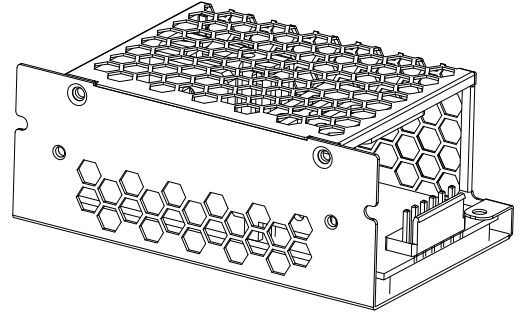

Side View

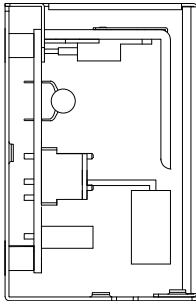

Side View

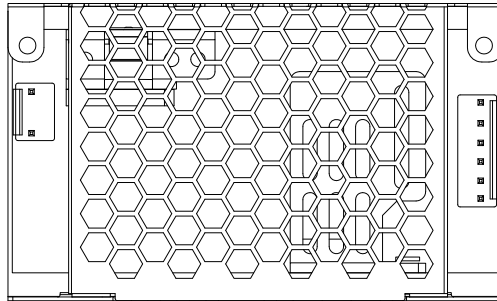

Top View

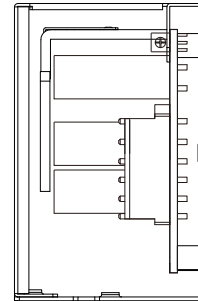

Side View

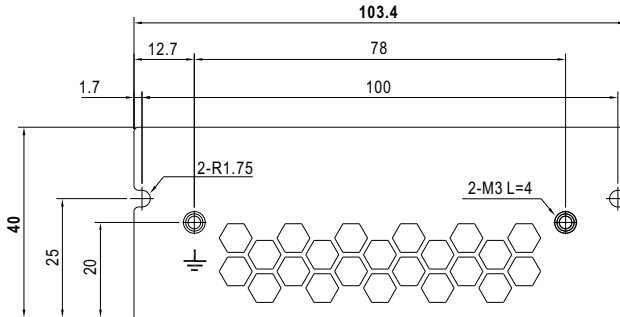

Side View

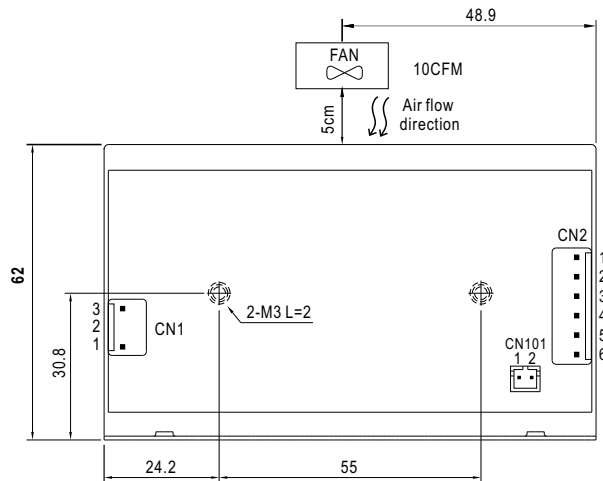

Bottom View

AC Input Connector (CN1) : JST B3P-VH or equivalent

Pin No.	Assignment	Mating Housing	Terminal
1	AC/L	JST VHR or equivalent	JST SVH-21T-P1.1 or equivalent
2	No Pin		
3	AC/N		

DC Output Connector (CN2) : JST B6P-VH or equivalent

Pin No.	Assignment	Mating Housing	Terminal
1,2,3	+V	JST VHR or equivalent	JST SVH-21T-P1.1 or equivalent
4,5,6	-V		

FAN Connector(CN101) : JST B2B-PH-K-S or equivalent

Pin No.	Assignment	Mating Housing	Terminal
1	+12V	JST PHR-2 or equivalent	JST SPH-002T-P0.5S or equivalent
2	DC COM		

※Note : 1. The FAN supply is designed to serve as the source of the additive external fan for the cooling of the power supply, enabling the full load delivery and assuring the best life span of the product. Please do not use this FAN supply to drive other devices.

2.The PCB type(Blank type)EMI Conduction for Class B. Radiation for Class B with FG(Class I ) and Class A without FG(Class II)

3.The enclosed type(-C type) model is not suitable for the configuration within a Class II (no FG) system but is suggested to used within a Class I (with FG) system.

### ■ Installation Manual

Please refer to : <http://www.meanwell.com/manual.html>