

Dimension			
L	W	H	
300	85	41 (1U)	mm
11.8	3.35	1.61 (1U)	inch

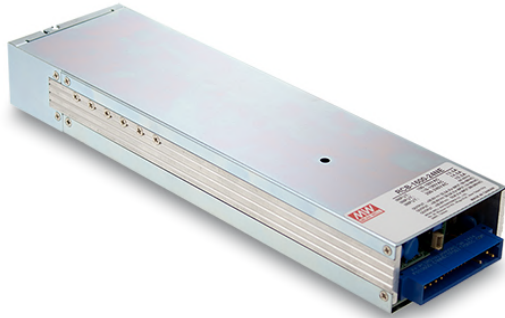

Front

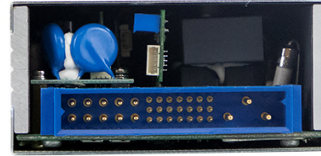

Back

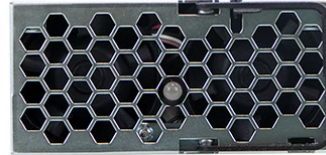

Features

- Universal AC input / Full range (Withstand 300VAC surge input for 5 seconds)
- Built-in active PFC function
- High efficiency up to 93%
- Forced air cooling by built-in DC fan
- Output voltage and constant current level programmable
- Built-in OR-ing FET, support hot swap (hot plug)
- Active current sharing up to 8000W for one 19" rack shelf
- Built-in I²C interface, PMBus protocol (Optional CANBus protocol)
- Protections: Short circuit / Overload / Over voltage / Over temperature
- Optional conformal coating
- 5 years warranty

Applications

- Industrial automation
- Distributed power architecture system
- Wireless/telecommunication solution
- Redundant power system
- Electric vehicle charger system
- Constant current source system

GTIN CODE

MW Search: <https://www.meanwell.com/serviceGTIN.aspx>

Description

RCP-1600 is a 1.6KW single output rack mountable front end AC/DC power supply with a 1U low profile and a high power density up to 25W/inch³. This series operates for 90~264VAC input voltage and offers the models with the DC output mostly demanded from the industry. Each model is cooled by the built-in DC fan with fan speed control, working for the temperature up to 70°C. RCP-1600 provides vast design flexibility by equipping various built-in functions such as the PMBus and CANBus communication protocol, output programming, active current sharing (up to 24000W via three 19" rack shelves, RHP-1U), remote control, auxiliary power, alarm signal, etc. Maximum number that can be monitored by master controller in communication shall be 15 power supplies.

Model Encoding / Order Information

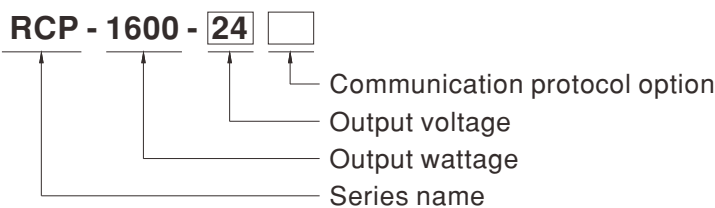

※ Note 1: 19" rack shelf, RHP-1U, available. Details available on <http://www.meanwell.com/>

※ Note 2: Control/Monitor unit, RKP-CMU1, available. Details available on <http://www.meanwell.com/>

Type	Communication Protocol	Note
Blank	PMBus protocol	In Stock
CAN	CANBus protocol	By request

SPECIFICATION

MODEL	RCP-1600-12	RCP-1600-24	RCP-1600-48	
OUTPUT	DC VOLTAGE	12V	24V	48V
	RATED CURRENT	125A	67A	33.5A
	CURRENT RANGE	0 ~ 125A	0 ~ 67A	0 ~ 33.5A
	RATED POWER	1500W	1608W	1608W
	RIPPLE & NOISE (max.) <small>Note.2</small>	150mVp-p	200mVp-p	300mVp-p
	VOLTAGE ADJ. RANGE <small>Note.6</small>	11.5 ~ 15V	23.5 ~ 30V	47.5 ~ 58.8V
	VOLTAGE TOLERANCE <small>Note.4</small>	±1.0%	±1.0%	±1.0%
	LINE REGULATION	±0.5%	±0.5%	±0.5%
	LOAD REGULATION	±0.5%	±0.5%	±0.5%
	SETUP, RISE TIME	1500ms, 60ms/230VAC at full load		
HOLD UP TIME (Typ.)	16ms / 230VAC at 75% load	10ms / 230VAC at full load		
INPUT	VOLTAGE RANGE <small>Note.5</small>	90 ~ 264VAC 250 ~ 370VDC		
	FREQUENCY RANGE	47 ~ 63Hz		
	POWER FACTOR (Typ.)	0.97/230VAC at full load		
	EFFICIENCY (Typ.)	88.5%	91%	93%
	AC CURRENT (Typ.) <small>Note.5</small>	14A/115VAC 8A/230VAC	15A/115VAC 8.5A/230VAC	
	INRUSH CURRENT (Typ.)	COLD START 35A/230VAC		
	LEAKAGE CURRENT	<1.5mA / 230VAC		
PROTECTION	OVERLOAD	105 ~ 115% rated current Protection type : Constant current limiting, shut down O/P voltage after 5 sec. After O/P voltage falls, re-power on to recover		
	OVER VOLTAGE	15.75 ~ 18.75V	31.5 ~ 37.5V	63 ~ 75V
	OVER TEMPERATURE	Shut down o/p voltage, recovers automatically after temperature goes down		
FUNCTION	OUTPUT VOLTAGE PROGRAMMABLE(PV) <small>Note 6</small>	Adjustment of output voltage is allowable to 40 ~ 125% of nominal output voltage(60~125% for 12V). Please refer to the Function Manual in following pages.		
	OUTPUT CURRENT PROGRAMMABLE(PC) <small>Note 6</small>	Adjustment of constant current level is allowable to 20 ~ 100% of rated current. Please refer to the Function Manual in following pages.		
	REMOTE ON-OFF CONTROL	By electrical signal or dry contact Power ON:short Power OFF:open. Please refer to the Function Manual in following pages.		
	REMOTE SENSE	Compensate voltage drop on the load wiring up to 0.5V. Please refer to the Function Manual in following pages.		
	AUXILIARY POWER	5V @ 0.3A, 12V @ 0.8A		
ALARM SIGNAL	Isolated TTL signal output for T-Alarm, AC-OK and DC-OK			
ENVIRONMENT	WORKING TEMP.	-30 ~ +70°C (Refer to "Derating Curve")		
	WORKING HUMIDITY	20 ~ 90% RH non-condensing		
	STORAGE TEMP., HUMIDITY	-40 ~ +85°C, 10 ~ 95% RH non-condensing		
	TEMP. COEFFICIENT	±0.03%/°C (0 ~ 50°C)		
	VIBRATION	10 ~ 500Hz, 2G 10min./1cycle, 60min. each along X, Y, Z axes		
SAFETY & EMC (Note 8)	SAFETY STANDARDS	UL62368-1, CAN/CSA C22.2 No. 62368-1, TUV BS EN/EN62368-1, EAC TP TC 004 approved		
	WITHSTAND VOLTAGE	I/P-O/P:3KVAC I/P-FG:2KVAC O/P-FG:1.5KVAC (0.5KVAC for 12V)		
	ISOLATION RESISTANCE	I/P-O/P, I/P-FG, O/P-FG:100M Ohms / 500VDC / 25°C / 70% RH		
	EMC EMISSION	Parameter	Standard	Test Level / Note
		Conducted	BS EN/EN55032 (CISPR32)	Class B
		Radiated	BS EN/EN55032 (CISPR32)	Class A
		Harmonic Current	BS EN/EN61000-3-2	Class A
	EMC IMMUNITY	Parameter	Standard	Test Level / Note
		ESD	BS EN/EN61000-4-2	Level 3, 8KV air ; Level 2, 4KV contact
		Radiated	BS EN/EN61000-4-3	Level 3
EFT / Burst		BS EN/EN61000-4-4	Level 3	
Surge		BS EN/EN61000-4-5	Level 4, 2KV/Line-Line 4KV/Line-Earth	
Conducted		BS EN/EN61000-4-6	Level 3	
Magnetic Field		BS EN/EN61000-4-8	Level 4	
Voltage Dips and Interruptions		BS EN/EN61000-4-11	>95% dip 0.5 periods, 30% dip 25 periods, >95% interruptions 250 periods	
OTHERS	MTBF	483.3K hrs min. Telcordia SR-332 (Bellcore) ; 39.4K hrs min. MIL-HDBK-217F (25°C)		
	DIMENSION	300*85*41mm (L*W*H)		
	PACKING	1.87Kg; 6pcs/12.2Kg/1.16CUFT		
NOTE	<p>1. All parameters NOT specially mentioned are measured at 230VAC input, rated load and 25°C of ambient temperature.</p> <p>2. Ripple & noise are measured at 20MHz of bandwidth by using a 12" twisted pair-wire terminated with a 0.1uf & 47uf parallel capacitor.</p> <p>3. Under parallel operation ripple of the output voltage may be higher than the SPEC at light load condition. It will go back to normal ripple level once the output load is more than 5%.</p> <p>4. Tolerance : includes set up tolerance, line regulation and load regulation.</p> <p>5. Derating may be needed under low input voltages. Please check the derating curve for more details.</p> <p>6. PV/PC functions when users are not operating on PMBus/CANBus. SVR functions when users are neither operating on PMBus/CANBus nor using PV/PC.</p> <p>7. Output will shut down after O/P voltage is below < 80% of Vset for 5 sec, re-power on to recover.</p> <p>8. The power supply is considered a component which will be installed into a final equipment. All the EMC tests are been executed by mounting the unit on a 720mm*360mm metal plate with 1mm of thickness. The final equipment must be re-confirmed that it still meets EMC directives. For guidance on how to perform these EMC tests, please refer to "EMI testing of component power supplies." (as available on https://www.meanwell.com/Upload/PDF/EMI_statement_en.pdf)</p> <p>9. The ambient temperature derating of 3.5°C/1000m with fanless models and of 5°C/1000m with fan models for operating altitude higher than 2000m(6500ft).</p> <p>※ Product Liability Disclaimer : For detailed information, please refer to https://www.meanwell.com/serviceDisclaimer.aspx</p>			

Block Diagram

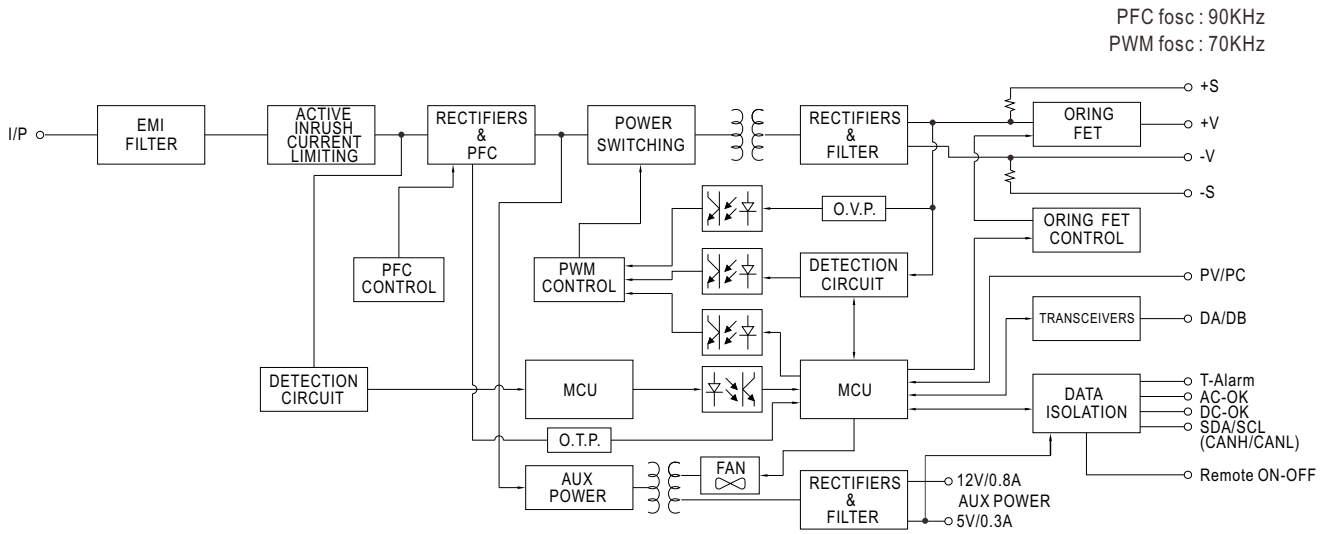

Static Characteristics

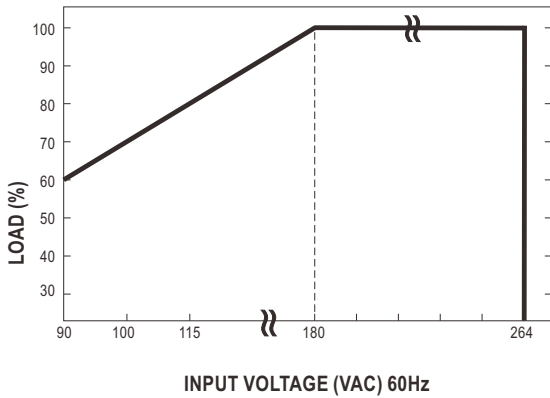

Derating Loads vs Input Voltage

INPUT \ MODEL	12V	24V	48V
180-264VAC	1500W 125A	1608W 67A	1608W 33.5A
115VAC	1200W 100A	1286.4W 53.6A	1286.4W 26.8A
100VAC	1050W 87.5A	1125.6W 46.9A	1125.6W 23.45A
90VAC	900W 75A	964.8W 40.2A	964.8W 20.1A

Derating Curve

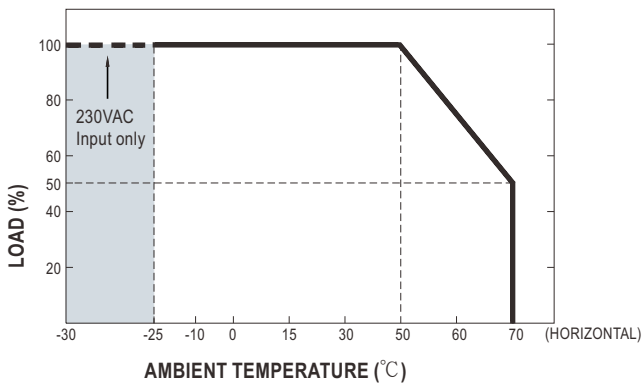

Efficiency vs Load (48V Model)

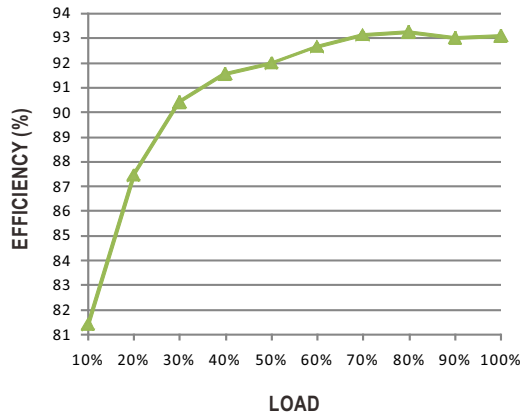

© The curve above is measured at 230VAC.

Function Manual

1. Voltage Drop Compensation

1.1 Remote Sense

※ The Remote Sense compensates voltage drop on the load wiring up to 0.5V

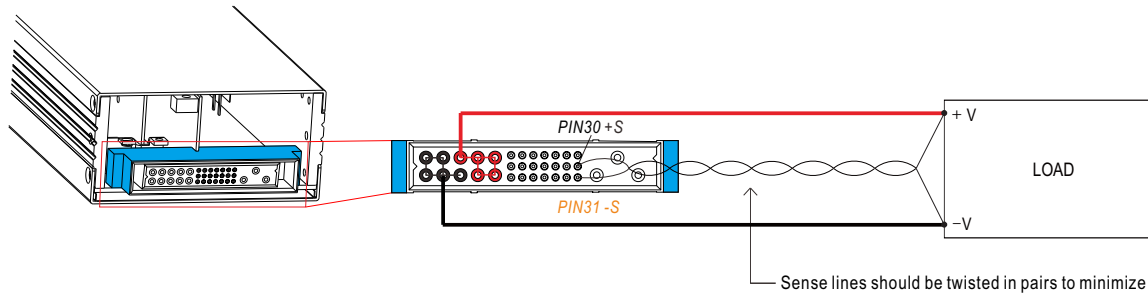

◎ The +S signal should be connected to the positive terminal of the load whereas -S signal to the negative terminal.

1.2 Local Sense

※ The +S,-S have to be connected to the +V(signal),-V(signal), respectively, as the following diagram, in order to get the correct output voltage if Remote Sense is not used.

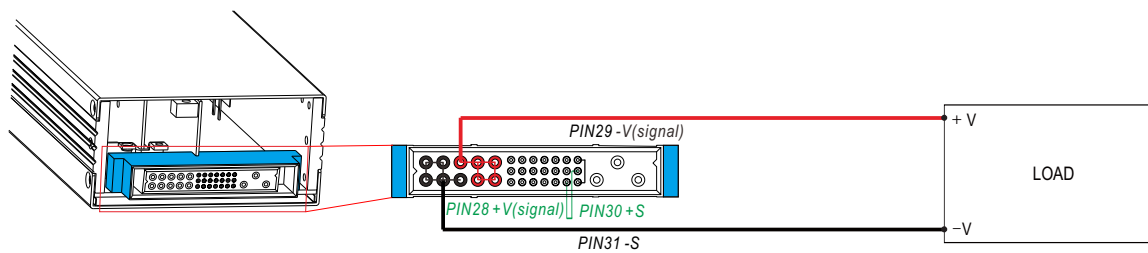

2. Output Voltage Programming (or, PV / remote voltage programming / remote adjust / margin programming / dynamic voltage trim)

※ In addition to the adjustment via the built-in potentiometer, the output voltage can be trimmed to 40~125% of the nominal voltage by applying EXTERNAL VOLTAGE.

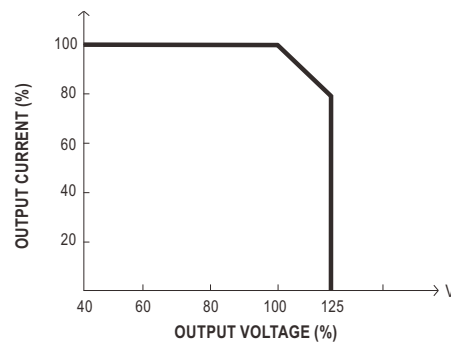
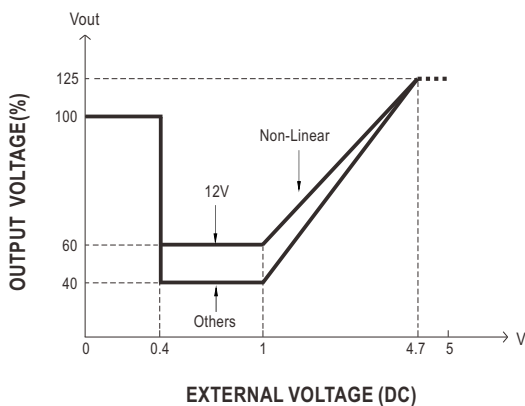
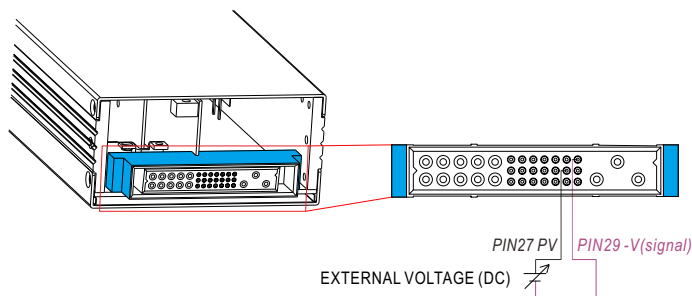

◎ The rated current should change with the Output Voltage Programming accordingly.

◎ For Remote Sense / Local Sense, please refer to "Voltage Drop Compensation" section.

3. Constant Current Level Programming (or, PC / remote current programming / dynamic current trim)

※ The constant current level can be trimmed to 20~100% of the rated current by applying EXTERNAL VOLTAGE.

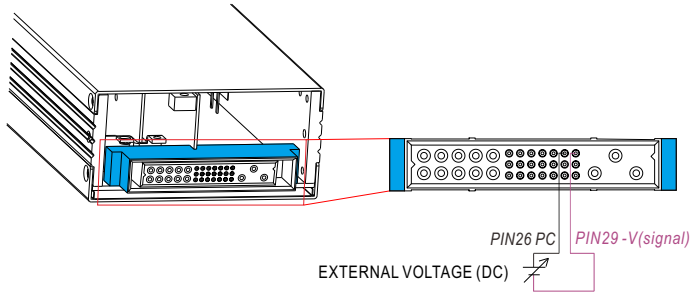

- For Remote Sense / Local Sense, please refer to "Voltage Drop Compensation" section.
- Output will shut down after O/P voltage is below < 80% of Vset for 5 sec, re-power on to recover .

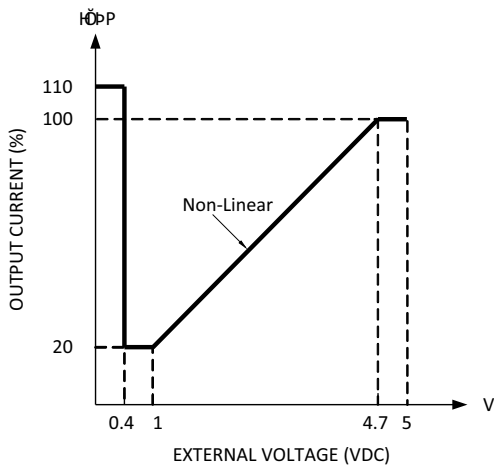

4. Remote ON-OFF Control

The power supply can be turned ON/OFF individually or along with other units by using the "Remote ON-OFF" function.

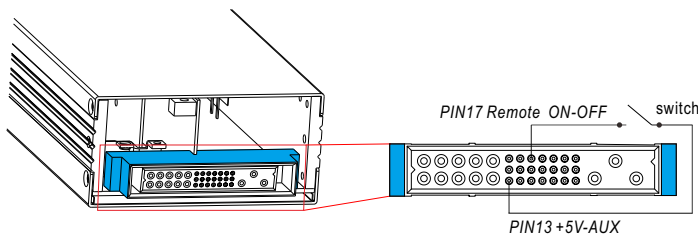

Between Remote ON-OFF and +5V-AUX	Power Supply Status
Switch Short	ON
Switch Open	OFF

5.PMBus Communication Interface

RCP-1600 supports PMBus Rev. 1.1 with maximum 100KHz bus speed, allowing information reading, status monitoring, output trimming, etc. For details, please refer to the Function Manual.

■ Mechanical Specification

(Unit: mm , tolerance ±0.5mm)

Case No.250

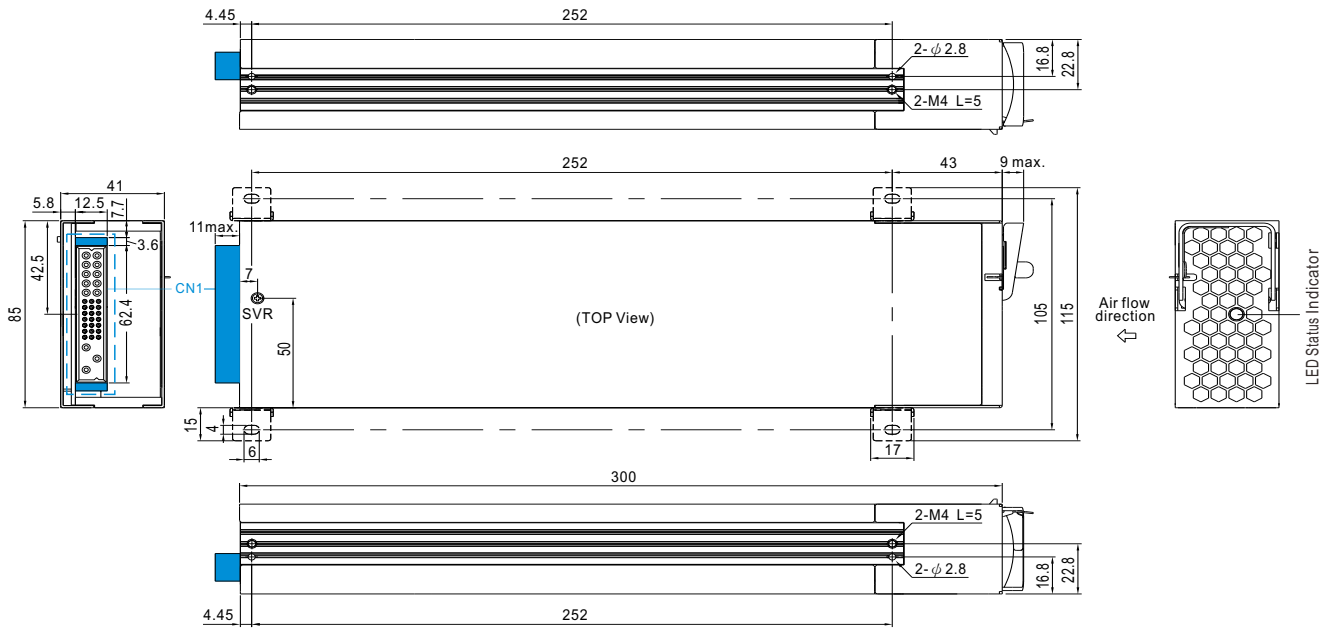

※ LED Status Indicators

LED	Description
	The power supply functions normally.
	The LED will present a constant red light when the abnormal status (OTP, OLP, fan fail) arises.
	The LED will flash with the red light when the internal temperature reaches 60°C; under this condition, the unit still operates normally without entering OTP. (In the meantime, an alarm signal will be sent out through the PMBus interface.)

※ Input / Output Connector Pin No. Assignment(CN1) : Positronic PCIM34W13M400A1

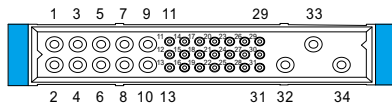

Mating Housing Positronic PCIM34W13F400A1

Pin No.	Function	Description
1,2,3,4,6	-V	Negative output terminal. (48V model only possesses Pin 1, 3, 4)
5,7,8,9,10	+V	Positive output terminal. (48V model only possesses Pin 5, 7, 9)
11	+12V-AUX	Auxiliary voltage output, 10.8~13.2V, referenced to GND-AUX (pin 12). The maximum load current is 0.8A. This output has the built-in "Oring diodes" and is not controlled by the Remote ON/OFF control.
12	GND-AUX	Auxiliary voltage output GND. The signal return is isolated from the output terminals (+V & -V).
13	+5V-AUX	Auxiliary voltage output, 4.5~5.5V, referenced to GND-AUX (pin 12). The maximum load current is 0.3A. This output has the built-in "Oring diodes" and is not controlled by the Remote ON/OFF control.
14	SCL	For PMBus model: Serial Clock used in the PMBus interface. (Note.2)
	CANL	For CANBus model: Data line used in CANBus interface. (Note.2)
15	SDA	For PMBus model: Serial Data used in the PMBus interface. (Note.2)
	CANH	For CANBus model: Data line used in CANBus interface. (Note.2)
16	T-ALARM	High (3.5 ~ 5.5V) : When the internal temperature exceeds the limit of temperature alarm, or when fan fails.
		Low (-0.5 ~ 0.5V) : When the internal temperature is normal, and when fan normally works. The maximum sourcing current is 10mA and only for output.(Note.2)
17	Remote ON-OFF	The unit can turn the output ON/OFF by electrical signal or dry contact between Remote ON/OFF and +5V-AUX. (Note.2) Short (4.5 ~ 5.5V) : Power ON ; Open (-0.5 ~ 0.5V) : Power OFF ; The maximum input voltage is 5.5V.
18	DC-OK	High (3.5 ~ 5.5V) : When the Vout ≤ 77%±5%.
		Low (-0.5 ~ 0.5V) : When Vout ≥ 80%±5%. The maximum sourcing current is 10mA and only for output. (Note.2)
19	AC-OK	High (3.5 ~ 5.5V) : When the input voltage is ≥ 87Vrms .
		Low (-0.5 ~ 0.5V) : When the input voltage is ≤ 75Vrms. The maximum sourcing current is 10mA and only for output. (Note.2)
20,21,22,23	A3,A2,A1,A0	PMBus / CANBus interface address lines. (Note.1)
24,25	DB,DA	Differential digital signal for parallel control. (Note.1)
26	PC	Connection for constant current level programming. (Note.1)
27	PV	Connection for output voltage programming. (Note.1)
28	+V (Signal)	Positive output voltage signal. It is for local sense; it cannot be connected directly to the load.
29	-V (Signal)	Negative output voltage signal. It is for local sense; and certain function reference; it cannot be connected directly to the load.
30	+S	Positive sensing for remote sense.
31	-S	Negative sensing for remote sense.
32	FG	AC Ground connection.
33	AC/L	AC Line connection.
34	AC/N	AC Neutral connection.

Note1: Non-isolated signal, referenced to [-V(signal)].
Note2: Isolated signal, referenced to GND-AUX.