

| Dimension | | | |
|-----------|------|-----------|------|
| L | W | H | |
| 300 | 85 | 41 (1U) | mm |
| 11.8 | 3.35 | 1.61 (1U) | inch |

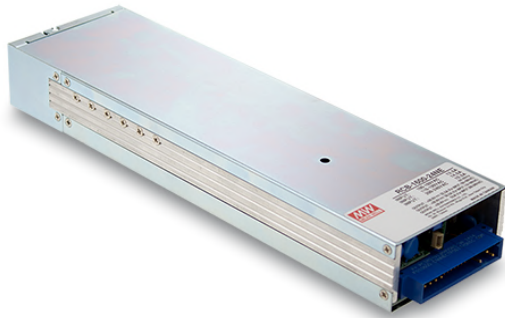

Front

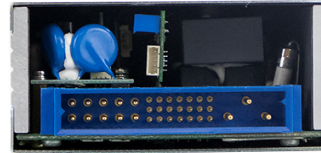

Back

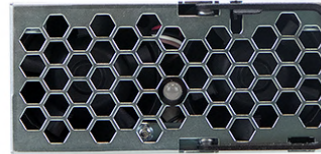

UL62368-1

BS EN/EN62368-1

TPTC004

IEC62368-1



Features

- Charger for lead-acid batteries (Gel, flooded and AGM) and Li-ion batteries (lithium iron and lithium manganese)
- Built-in default 3 stage charging curves and programmable curve
- Built-in I²C interface, PMBus protocol (Optional CANBus protocol)
- Output voltage and current programmable
- Universal AC input / Full range (Withstand 300VAC surge input for 5 seconds)
- Built-in active PFC function
- Forced air cooling by built-in DC fan
- Built-in OR-ing FET, support hot swap (hot plug)
- Active current sharing up to 8000W for one 19" rack shelf
- Protections: Battery under voltage / Battery no connection / Short circuit / Over voltage / Over temperature
- Optional conformal coating
- 5 years warranty

Applications

- Large scale DC UPS or emergency backup system
- Marine battery charger module
- Electric scooter or vehicle charger station
- Wastewater treatment system
- Electrolysis system

GTIN CODE

MW Search: <https://www.meanwell.com/serviceGTIN.aspx>

Description

RCB-1600 series is a single output 1600W AC/DC charger with 1U low profile (41mm). It is an intelligent charger with embedded charging curves which are programmable. Users are also able to adjust the charging voltage and current via the built-in potentiometer, output programmable functions, PMBus, or CANBus to charge different types of batteries, such as lead-acid batteries and li-ion batteries. Various protection mechanisms as well as the temperature compensation function are provided to assure the normal and safe operations. The rack-mountable attribute allows RCB-1600 to perfectly suit the charging, backup or constant current source applications exploiting the rack architecture or central management.

Model Encoding

RCB - 1600 - 12

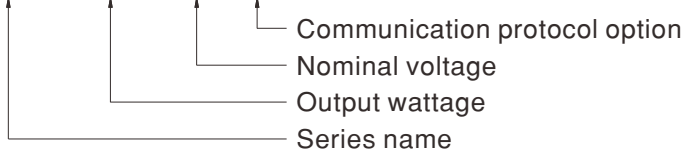

※ Note: 19" rack shelf, RHP-1U, available.

| Type | Communication Protocol | Note |
|-------|------------------------|------------|
| Blank | PMBus protocol | In Stock |
| CAN | CANBus protocol | By request |



SPECIFICATION

| MODEL | RCB-1600-12 | RCB-1600-24 | RCB-1600-48 | |
|--|--|--|------------------------|--------------|
| OUTPUT | BOOST CHARGE VOLTAGE(Vboost)(default) | 14.4V | 28.8V | 57.6V |
| | FLOAT CHARGE VOLTAGE(Vfloat)(default) | 13.8V | 27.6V | 55.2V |
| | CONSTANT CURRENT(CC)(default) | 100A | 55A | 27.5A |
| | RATED POWER | 1440W | 1584W | 1584W |
| | VOLTAGE ADJ. RANGE | By built-in potentiometer, SVR | | |
| | | 11.5 ~ 15V | 23.5 ~ 30V | 47.5 ~ 58.8V |
| | RECOMMENDED BATTERY CAPACITY(AMP HOURS) Note.3 | 330 ~ 1000Ah | 180 ~ 550Ah | 90 ~ 270Ah |
| LEAKAGE CURRENT FROM BATTERY (Typ.) Note.8 | <45mA | | | |
| INPUT | VOLTAGE RANGE Note.4 | 90 ~ 264VAC 250 ~ 370VDC | | |
| | FREQUENCY RANGE | 47 ~ 63Hz | | |
| | POWER FACTOR (Typ.) | 0.97/230VAC at full load | | |
| | EFFICIENCY (Typ.) | 90.5% | 92% | 93% |
| | AC CURRENT (Typ.) Note.4 | 14A/115VAC 8A/230VAC | 15A/115VAC 8.5A/230VAC | |
| | INRUSH CURRENT (Typ.) | COLD START 35A/230VAC | | |
| | LEAKAGE CURRENT | <1.5mA / 230VAC | | |
| PROTECTION | OVER VOLTAGE | 15.75 ~ 18.75V | 31.5 ~ 37.5V | 63 ~ 75V |
| | | Protection type : Shut down o/p voltage, re-power on to recover | | |
| | OVER TEMPERATURE | Shut down o/p voltage, recovers automatically after temperature goes down | | |
| FUNCTION | OUTPUT VOLTAGE PROGRAMMABLE(PV) Note 5 | Adjustment of output voltage is allowable to 75 ~ 125% of nominal output voltage Please refer to the Function Manual. | | |
| | OUTPUT CURRENT PROGRAMMABLE(PC) Note 5 | Adjustment of output current is allowable to 20 ~ 100% of rated current Please refer to the Function Manual. | | |
| | AUXILIARY POWER | 5V @ 0.3A, 12V @ 0.8A | | |
| | REMOTE ON-OFF CONTROL | By electrical signal or dry contact Power ON:short Power OFF:open. Please refer to the Function Manual | | |
| | TEMPERATURE COMPENSATION | -3mV / °C / cell / (12V = 6 cells ; 24V = 12 cells ; 48V = 24 cells) | | |
| | DC OK SIGNAL | The isolated TTL signal out. Please refer to the Installation Manual | | |
| | AC OK SIGNAL | The isolated TTL signal out. Please refer to the Installation Manual | | |
| ENVIRONMENT | WORKING TEMP. | -30 ~ +70°C (Refer to "Derating Curve") | | |
| | WORKING HUMIDITY | 20 ~ 90% RH non-condensing | | |
| | STORAGE TEMP., HUMIDITY | -40 ~ +85°C, 10 ~ 95% RH non-condensing | | |
| | TEMP. COEFFICIENT | ±0.03%/°C (0 ~ 50°C) | | |
| | VIBRATION | 10 ~ 500Hz, 2G 10min./1cycle, 60min. each along X, Y, Z axes | | |
| SAFETY & EMC (Note 6) | SAFETY STANDARDS | UL62368-1, TUV BS EN/EN62368-1, EAC TP TC 004 approved | | |
| | WITHSTAND VOLTAGE | I/P-O/P:3KVAC I/P-FG:2KVAC O/P-FG:1.5KVAC (0.5KVAC for 12V) | | |
| | ISOLATION RESISTANCE | I/P-O/P, I/P-FG, O/P-FG:100M Ohms / 500VDC / 25°C / 70% RH | | |
| | EMC EMISSION | Compliance to BS EN/EN55032 (CISPR32) Conduction Class B, Radiation Class A ; BS EN/EN61000-3-2,-3, EAC TP TC 020 | | |
| | EMC IMMUNITY | Compliance to BS EN/EN61000-4-2,3,4,5,6,8,11, BS EN/EN55035, EAC TP TC 020 | | |
| OTHERS | MTBF | 476.7K hrs min. Telcordia SR-332 (Bellcore) ; 38.7K hrs min. MIL-HDBK-217F (25°C) | | |
| | DIMENSION | 300*85*41mm (L*W*H) | | |
| | PACKING | 1.87Kg; 6pcs/12.2Kg/1.16CUFT | | |
| NOTE | <p>1. Modification for charger specification may be required for different battery specification. Please contact battery vendor and MEAN WELL for details.</p> <p>2. All parameters NOT specially mentioned are measured at 230VAC input, rated load and 25°C of ambient temperature.</p> <p>3. This is MEAN WELL's suggested range. Please consult your battery manufacturer for their suggestions about maximum charging current limitation.</p> <p>4. Derating may be needed under low input voltages. Please check the derating curve for more details.</p> <p>5. PV/PC functions when users are not operating on PMBus/CANBus. SVR functions when users are neither operating on PMBus/CANBus nor using PV/PC.</p> <p>6. The charger is considered a component which will be installed into a final equipment. All the EMC tests are been executed by mounting the unit on a 720mm*360mm metal plate with 1mm of thickness. The final equipment must be re-confirmed that it still meets EMC directives. For guidance on how to perform these EMC tests, please refer to "EMI testing of component power supplies." (as available on https://www.meanwell.com/Upload/PDF/EMI_statement_en.pdf)</p> <p>7. The ambient temperature derating of 3.5°C/1000m with fanless models and of 5°C/1000m with fan models for operating altitude higher than 2000m(6500ft).</p> <p>8. When charging lead acid battery or battery without BMS, use breaker to disconnect charger and battery after fully charged.</p> <p>※ Product Liability Disclaimer : For detailed information, please refer to https://www.meanwell.com/serviceDisclaimer.aspx</p> | | | |

Block Diagram

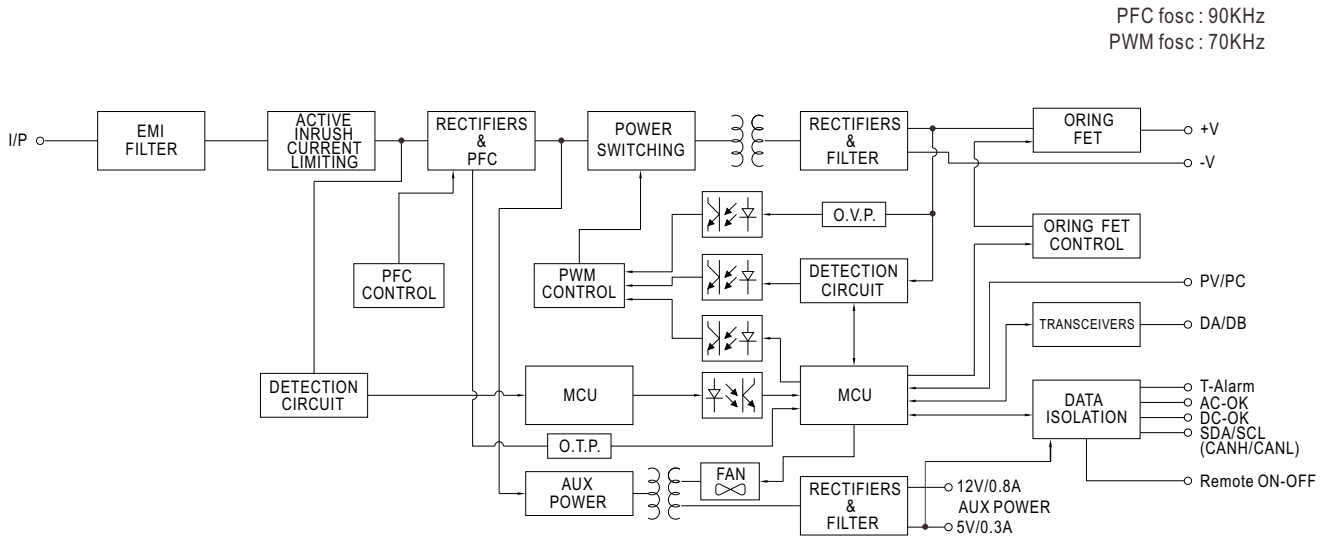

Derating Curve

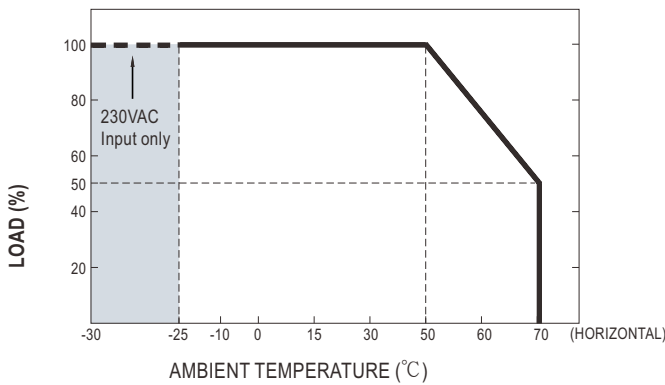

Static Characteristics

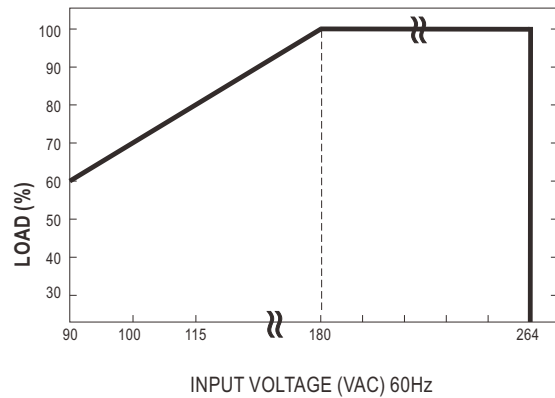

Function Manual

1. PMBus Communication Interface

※ RCB-1600 supports PMBus Rev. 1.1 with maximum 100KHz bus speed, allowing information reading, status monitoring, output trimming, etc. For details, please refer to the Installation Manual.

2. Charging Curve

- ※ By factory default, this charger performs the default curve which can be programmed via PMBus and CANBus.
- ※ To disable/enable the charging curve or charging timeout in each stage, change to a 2 stage curve or to a different curve frequently used for certain types of batteries in the industry, switch to PMBus, CANBus, PV/PC or SVR control instead and so on, please refer to the Installation Manual.
- ※ To program the parameters of the charging curve, SBP-001, the smart battery charging programmer designed by MEAN WELL, and a personal computer are needed. Please contact MEAN WELL for details.

☉ Default 3 stage charging curve

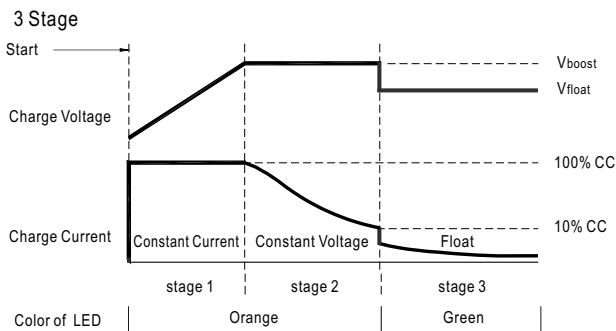

☉ Embedded 3 stage charging curve

| MODEL | Description | Vboost | Vfloat | CC (default) |
|-------|------------------------------|--------|--------|--------------|
| 12V | Default, programmable | 14.4 | 13.8 | 100A |
| | Pre-defined, gel battery | 14 | 13.6 | |
| | Pre-defined, flooded battery | 14.2 | 13.4 | |
| | Pre-defined, AGM battery | 14.5 | 13.5 | |
| 24V | Default, programmable | 28.8 | 27.6 | 55A |
| | Pre-defined, gel battery | 28 | 27.2 | |
| | Pre-defined, flooded battery | 28.4 | 26.8 | |
| | Pre-defined, AGM battery | 29 | 27 | |
| 48V | Default, programmable | 57.6 | 55.2 | 27.5A |
| | Pre-defined, gel battery | 56 | 54.4 | |
| | Pre-defined, flooded battery | 56.8 | 53.6 | |
| | Pre-defined, AGM battery | 58 | 54 | |

☉ Suitable for lead-acid batteries (flooded, Gel and AGM) and Li-ion batteries (lithium iron and lithium manganese).

3. Remote ON-OFF Control

The charger can be turned ON/OFF individually or along with other units in parallel by using the "Remote ON-OFF" function.

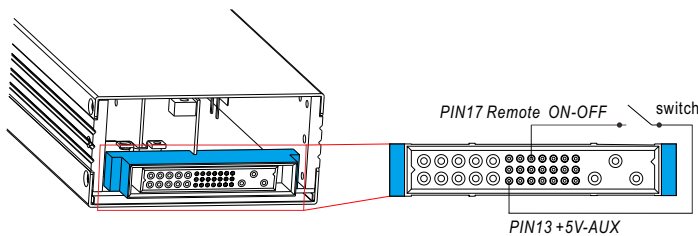

| Between Remote ON-OFF and +5V-AUX | Charger Status |
|-----------------------------------|----------------|
| Switch Short | ON |
| Switch Open | OFF |

4. Output Voltage Programming (or, PV / remote voltage programming / remote adjust / margin programming / dynamic voltage trim)

※ In addition to the adjustment via the built-in potentiometer, the output voltage can be trimmed to 75~125% of the nominal voltage by applying EXTERNAL VOLTAGE.

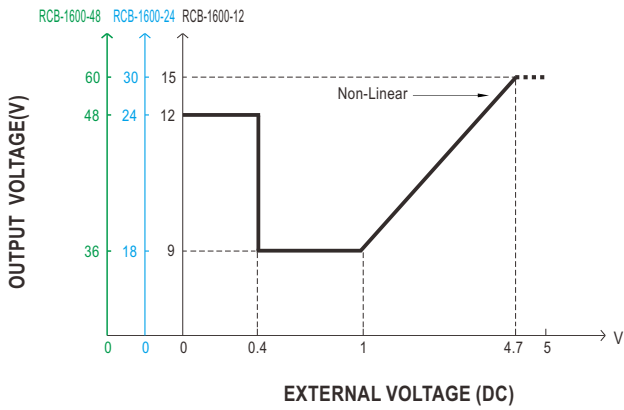
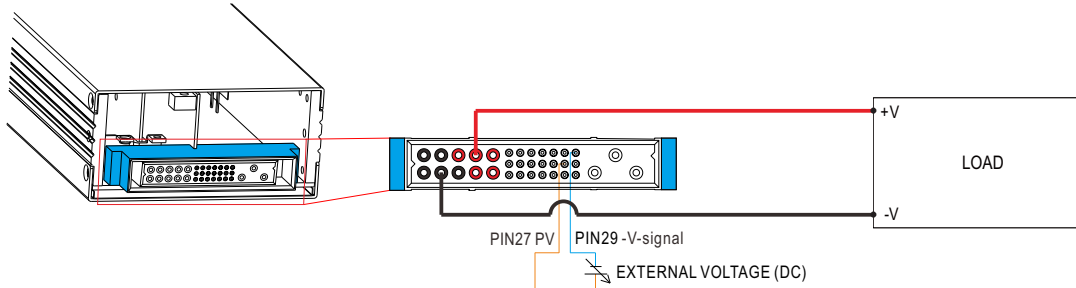

5. Output Current Programming (or, PC / remote current programming / dynamic current trim)

※ The output current can be trimmed to 20~100% of the rated current by applying EXTERNAL VOLTAGE.

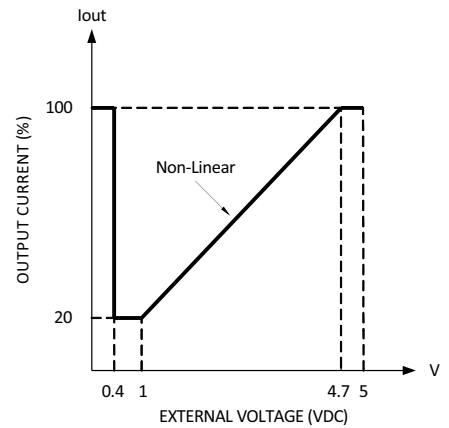
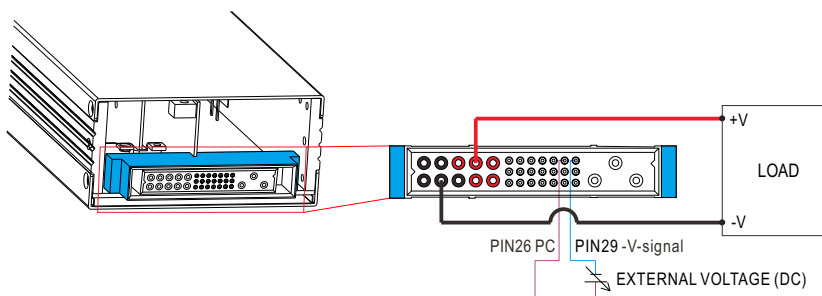

6. Temperature Compensation

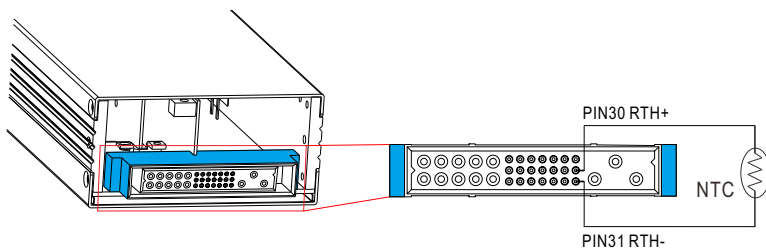

- ◎ To exploit the temperature compensation function, please attach the temperature sensor, NTC, to the battery or the battery's vicinity.
- ◎ The charger is able to work normally without the NTC.

Mechanical Specification

(Unit: mm , tolerance ±0.5mm)

Case No.250

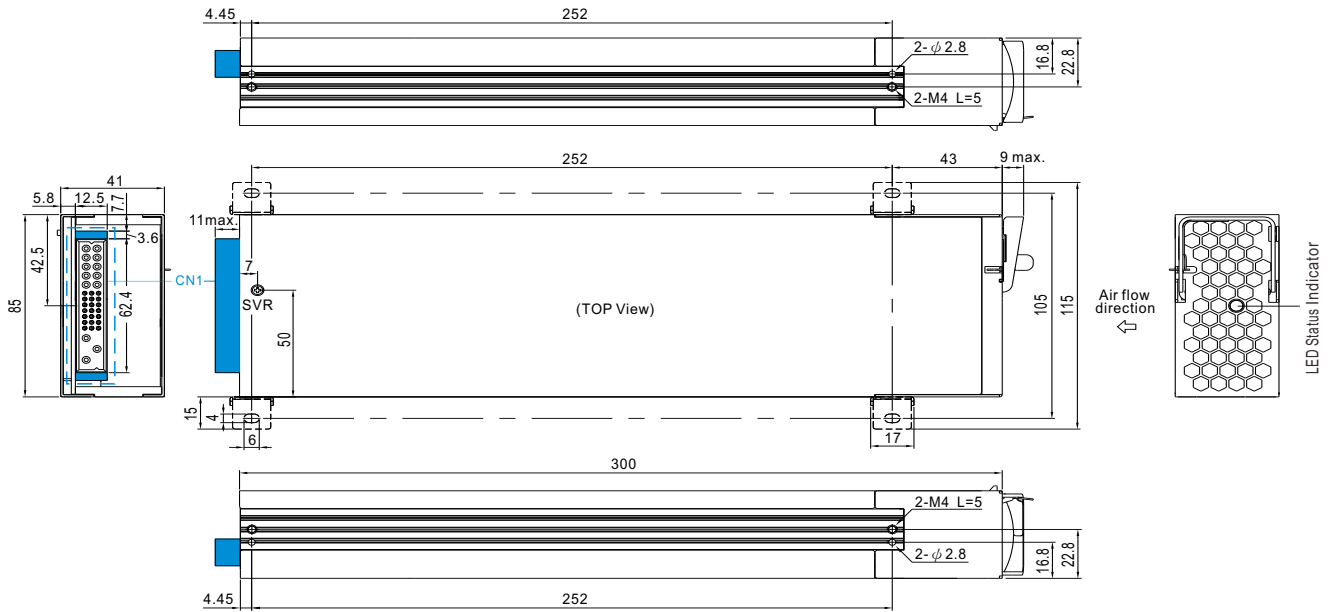

※ LED Status Indicators

| LED | Description |
|-----|---|
| | Float (stage 3) |
| | Charging (stage 1 or stage 2) |
| | The LED will present a constant red light when the abnormal status (OTP, OLP, fan fail and charging timeout) arises. |
| | The LED will flash with the red light when the internal temperature reaches 60°C; under this condition, the unit still operates normally without entering OTP. (In the meantime, an alarm signal will be sent out through the PMBus interface.) |

※ Input / Output Connector Pin No. Assignment(CN1) : Positronic PCIM34W13M400A1

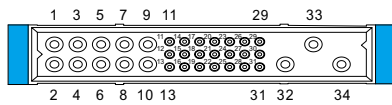

Mating Housing Positronic PCIM34W13F400A1

| Pin No. | Function | Description |
|------------|---------------|--|
| 1,2,3,4,6 | -V | Negative output terminal. |
| 5,7,8,9,10 | +V | Positive output terminal. |
| 11 | +12V-AUX | Auxiliary voltage output, 10.8~13.2V, referenced to GND-AUX (pin 12). The maximum load current is 0.8A. This output has the built-in "Oring diodes" and is not controlled by the Remote ON/OFF control. |
| 12 | GND-AUX | Auxiliary voltage output GND. The signal return is isolated from the output terminals (+V & -V). |
| 13 | +5V-AUX | Auxiliary voltage output, 4.5~5.5V, referenced to GND-AUX (pin 12). The maximum load current is 0.3A. This output has the built-in "Oring diodes" and is not controlled by the Remote ON/OFF control. |
| 14 | SCL | For PMBus model: Serial Clock used in the PMBus interface. (Note.2) |
| | CANL | For CANBus model: Data line used in CANBus interface. (Note.2) |
| 15 | SDA | For PMBus model: Serial Data used in the PMBus interface. (Note.2) |
| | CANH | For CANBus model: Data line used in CANBus interface. (Note.2) |
| 16 | T-ALARM | High (3.5 ~ 5.5V) : When the internal temperature exceeds the limit of temperature alarm, or when fan fails. Low (-0.5 ~ 0.5V) : When the internal temperature is normal, and when fan normally works. The maximum sourcing current is 10mA and only for output.(Note.2) |
| 17 | Remote ON-OFF | The unit can turn the output ON/OFF by electrical signal or dry contact between Remote ON/OFF and +5V-AUX. (Note.2) Short (4.5 ~ 5.5V) : Power ON ; Open (-0.5 ~ 0.5V) : Power OFF ; The maximum input voltage is 5.5V. |
| 18 | DC-OK | High (3.5 ~ 5.5V) : When the Vout ≤ 8V/16V/32V ± 1V. Low (-0.5 ~ 0.5V) : When Vout ≥ 8V/16V/32V ± 1V. The maximum sourcing current is 10mA and only for output. (Note.2) DC OK is associated with battery low protection. |
| 19 | AC-OK | High (3.5 ~ 5.5V) : When the input voltage is ≥ 87Vrms . Low (-0.5 ~ 0.5V) : When the input voltage is ≤ 75Vrms. The maximum sourcing current is 10mA and only for output. (Note.2) |
| 20 | D0 | Charging mechanism control. This pin determines, for charging operation, whether charging curve is used, or control over PMBus, PV/PC or SVR is used. Please refer to the installation Manual. (Note.1) |
| 21,22,23 | A2,A1,A0 | PMBus / CANBus interface address lines. (Note.1) |
| 24,25 | DB,DA | Differential digital signal for parallel control. (Note.1) |
| 26 | PC | Connection for output current programming. (Note.1) |
| 27 | PV | Connection for output voltage programming. (Note.1) |
| 28 | +V(signal) | Positive output voltage signal. It cannot be connected directly to the load. |
| 29 | -V(signal) | Negative output voltage signal. It is for certain function reference; it cannot be connected directly to the load. |
| 30 | RTH+ | Temperature sense associated with the temperature compensation function. |
| 31 | RTH- | |
| 32 | FG | AC Ground connection. |
| 33 | AC/L | AC Line connection. |
| 34 | AC/N | AC Neutral connection. |

Note1: Non-isolated signal, referenced to [-V(signal)].
Note2: Isolated signal, referenced to GND-AUX.