

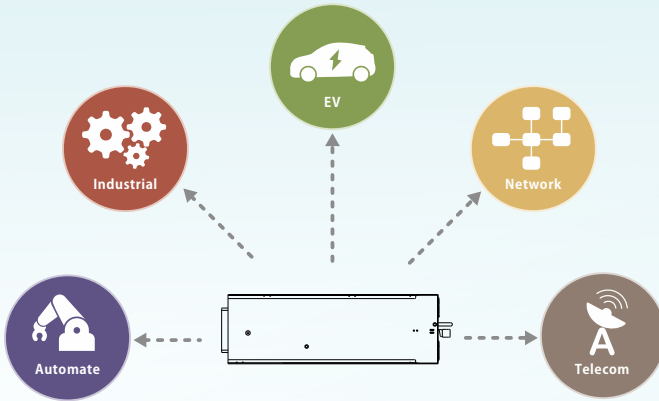

# NCP-3200/DHP-1UT-B(HV) Series User's Manual



## *2-in-1 Rack-mounted Switching Power Supply & Battery Charger*

- Built-in programmable output voltage and output current
- Active current sharing up to 10 rack shelves

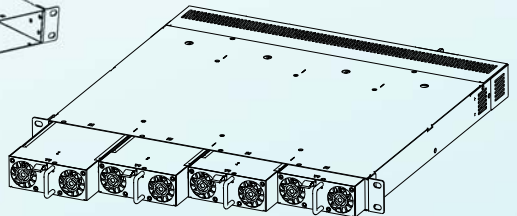
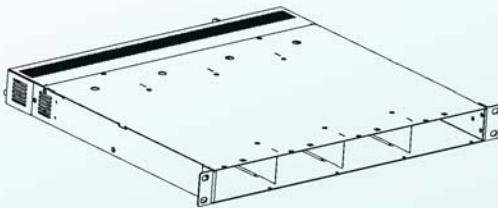

The NCP-3200 series, the new generation of rack-mounted power supplies, offers three output voltage models - DC 24V/ 48V and high-voltage DC 380V. To meet the application requirements of energy supply systems, the 24 V/48V models are specially designed to be switchable between DC power supply and charger modes for 2-in-1 applications via software settings. These models are suitable for various kinds of light/heavy industrial machinery and equipment, automation or mobile equipment, 5G or all kinds of communication base stations, charging piles or large charging stations, data server centers or energy storage systems and many others. In contrast, the high-voltage 380VDC output model is designed as a power supply solely, which is suitable for high-voltage centralized power supply, horticultural lighting systems, semiconductor equipment, energy storage equipment and many others. In terms of control functions, the NCP-3200 series has built-in programmable output voltage (PV) and programmable output current (PC), users can adjust the output voltage or current through external analog signals. For intelligent applications, the NCP-3200 series is equipped with PMBus and CANBus and also can be used directly with MEAN WELL's multi-industry general intelligent controller CMU2. Moreover, the NCP-3200 series can be easily combined with 19" Rack chassis in parallel to provide up to 128KW intelligent chassis, or stack each chassis in parallel to form a system power supply or charger with larger wattage.

# Contents

<b>1.Safety Guidelines</b>	1	5.12 Parallel Operation	35
<b>2.Introduction</b>	2	5.13 Series Operation	37
2.1 Model Encoding	2	5.14 Auxiliary Output	37
2.2 Features	3	5.15 Charge Function(24V/ 48V only)	38
2.3 Specification	4	5.16 Factory Reset	43
2.4 Static Characteristics	11	<b>6.Communication Protocol</b>	44
2.5 Derating Curve	11	6.1 PMBus Communication Interface	45
2.6 Mechanical Specification	12	6.2 CANBus Communication Interface	55
<b>3.Installation &amp; Wiring</b>	14	6.3 Value Range and Tolerance	68
3.1 Precautions	14	<b>7.Protections and Trouble Shooting</b>	70
3.2 Hot Swapping	15	7.1 Over Temperature Protection (OTP) and T Alarm	70
3.3 Wiring	16	7.2 Over Load Protection	71
3.4 Cable Size Selection	17	7.3 Over Voltage Protection	71
<b>4.Panel and LED indicator</b>	18	7.4 Trouble Shooting	71
4.1 NCP-3200 Panel Description	18	<b>8.Warranty</b>	72
4.2 DHP-1UT-B(HV) Panel Description	21	<b>A.Appendix</b>	74
4.3 LED Indicator	25		
4.4 Communication Address /ID Assignment	25		
<b>5.Operation</b>	29		
5.1 Input Voltage Range	29		
5.2 Inrush Current Limiting	29		
5.3 Output Power	29		
5.4 Power Factor Correction (PFC)	30		
5.5 Output Voltage Adjustment	30		
5.6 Output Current Adjustment	31		
5.7 Fan Speed Control	32		
5.8 AC-OK Signal	33		
5.9 $\overline{\text{DC-OK}}$ Signal	33		
5.10 Remote Control	34		
5.11 Remote Sense	34		

## 1.Safety Guidelines

- DHP-1UT-B is designed to be used with SELV (Safety Extra Low Voltage) and is only compatible with NCP-3200-24/48. If your application is for NCP-3200-380, please select DHP-1UT-BHV to prevent damage to the low voltage rack shelf.
- Risk of electrical shock and energy hazard, all failure should be examined by a qualified technician. Please do not remove the case form the power supply and rack shelf by yourself.
- Please do not change any component on the unit or make any kind of modification on it.
- Please do not install the supply in places with high moisture, high ambient temperature or under direct sunlight.
- The AC voltage range is 90 – 264Vac (47 – 63Hz), please do not connect the supply to AC gird out of the range.
- The safety protection level of this supply is class I. The Frame "Ground" ( $\perp$ ) of the unit must be well connected to PE (Protective Earth).

## 2.Introduction

### 2.1 Model Encoding

Single unit :

NCP - 3200 - 24

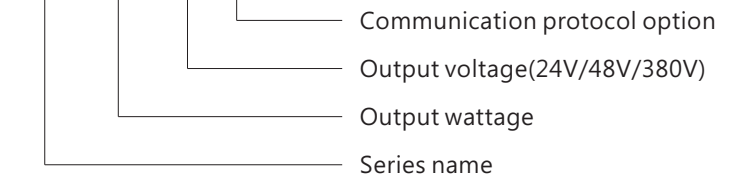

Type	Communication Protocol	Note
Blank	PMBus protocol	In Stock
CAN	CANBus protocol	In Stock

1U rack shelf :

DHP - 1U T - B

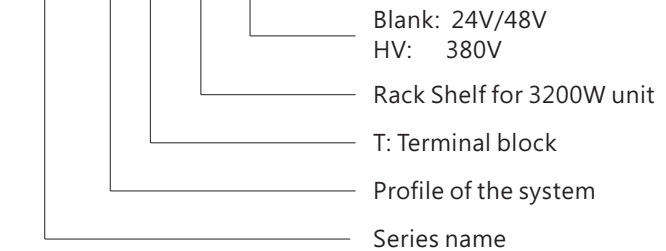

## 2.2 Features

- Universal AC input / Full range
- Power supply or charger mode selectable by PMBus, CANBus or SBP-001(only for 24V/48V models)
- Built-in 2/3 stage charging curves and programmable curve (only for 24V/48V models)
- High efficiency up to 94.5%
- Built-in programmable output voltage and output current
- Built-in OR-ing MOSFET or Diode, support hot swap (hot plug)
- Active current sharing up to 10 rack shelves and the maximum power supply that can be connected in parallel is 40 units
- Support PMBus/CANBus protocol
- Built-in intelligent fan speed control
- Protections: Short circuit / Overload / Over voltage / Over temperature
- Design refer to SEMI F47 standard specification
- 5 years warranty

## 2.3 Specification

### Specification For Power Supply Mode (Default)

MODEL	NCP-3200-24	NCP-3200-48	
OUTPUT	DC VOLTAGE (factory default)	24V	48V
	RATED CURRENT (factory default)	133A	67A
	CURRENT RANGE	0 ~ 133A	0 ~ 67A
	RATED POWER (max.)	3192W	3216W
	RIPPLE & NOISE (max.) Note.2,3	300mVp-p	480mVp-p
	VOLTAGE ADJ. RANGE	23.5 ~ 30V	47.5 ~ 58.8V
	VOLTAGE TOLERANCE Note.4	± 1.0%	± 1.0%
	LINE REGULATION	± 0.5%	± 0.5%
	LOAD REGULATION	± 0.5%	± 0.5%
	SETUP, RISE TIME	1500ms, 60ms/230VAC at full load	
HOLD UP TIME (Typ.)	16ms / 230VAC at 70% load	8ms / 230VAC at full load	
INPUT	VOLTAGE RANGE Note.6	90 ~ 264VAC	127 ~ 400VDC
	FREQUENCY RANGE	47 ~ 63Hz	
	POWER FACTOR (Typ.)	0.97/230VAC at full load	
	EFFICIENCY (Typ.) Note.7	93.5%	94.5%
	AC CURRENT (Typ.) Note.6	17A/230VAC	
	INRUSH CURRENT (Typ.)	COLD START 55A/230VAC	
	LEAKAGE CURRENT	<2mA / 230VAC	
PROTECTION	OVERLOAD	105 ~ 115% rated current Protection type : Constant current limiting, shut down O/P voltage after 5 sec. After O/P voltage falls, re-power on to recover	
	OVER VOLTAGE	31.5 ~ 37.5V	63 ~ 75V
	OVER TEMPERATURE	Shut down O/P voltage, recovers automatically after temperature goes down	
FUNCTION	OUTPUT VOLTAGE PROGRAMMABLE(PV)	Adjustment of output voltage is allowable to 50 ~ 125% of nominal output voltage Please refer to the Function Manual in following pages	
	CONSTANT CURRENT LEVEL PROGRAMMABLE(PC)	Adjustment of constant current level is allowable to 20 ~ 100% of rated current Please refer to the Function Manual in following pages	
	REMOTE ON-OFF CONTROL	By electrical signal or dry contact Power ON:short Power OFF:open. Please refer to the Function Manual in following pages	
	REMOTE SENSE	Compensate voltage drop on the load wiring up to 0.5V Please refer to the Function Manual in following pages	
	CURRENT SHARING	Active current sharing up to 10 rack shelves(DHP-1UT-B) and the maximum supply units that can be connected in parallel is 40	
	AUXILIARY POWER	5V @ 0.3A, tolerance ±10%, ripple 150mVp-p, 12V @ 0.8A, tolerance ±10%, ripple 450mVp-p	
	ALARM SIGNAL	Isolated TTL signal output for T-Alarm, AC-OK and DC-OK Please refer to the Function Manual in following pages	
ENVIRONMENT	WORKING TEMP.	-30 ~ +70°C (Refer to "Derating Curve")	
	WORKING HUMIDITY	20 ~ 90% RH non-condensing	
	STORAGE TEMP., HUMIDITY	-40 ~ +85°C, 10 ~ 95% RH non-condensing	
	TEMP. COEFFICIENT	±0.03%/°C (0 ~ 50°C)	
	VIBRATION	10 ~ 500Hz, 2G 10min./1cycle, 60min. each along X, Y, Z axes	

## Specification For Power Supply

MODEL		NCP-3200-380
OUTPUT	DC VOLTAGE (factory default)	380V
	CURRENT (factory default)	8.4A
	CURRENT RANGE	0 ~ 9.6A
	RATED POWER (max.)	3206.4W
	FULL POWER VOLTAGE RANGE	334 ~ 400V
	RIPPLE & NOISE (max.) Note.2,3	4000mVp-p
	VOLTAGE ADJ. RANGE	260 ~ 400V
	VOLTAGE TOLERANCE Note.4	± 1.0%
	LINE REGULATION	± 0.5%
	LOAD REGULATION	± 0.5%
	SETUP, RISE TIME	1500ms, 60ms/230VAC at full load
HOLD UP TIME (Typ.)	16ms / 230VAC at 70% load    8ms / 230VAC at full load	
INPUT	VOLTAGE RANGE Note.6	90 ~ 264VAC    127 ~ 400VDC
	FREQUENCY RANGE	47 ~ 63Hz
	POWER FACTOR (Typ.)	0.97/230VAC at full load
	EFFICIENCY (Typ.) Note.7	94%
	AC CURRENT (Typ.) Note.6	17A/230VAC
	INRUSH CURRENT (Typ.)	COLD START 55A/230VAC
LEAKAGE CURRENT	<2mA / 230VAC	
PROTECTION	OVERLOAD	105 ~ 115% of rated current Protection type : Constant current limiting, shut down O/P voltage after 5 sec. After O/P voltage falls, re-power on to recover
	OVER VOLTAGE	420 ~ 480V Protection type : Shut down o/p voltage, re-power on to recover
	OVER TEMPERATURE	Shut down O/P voltage, recovers automatically after temperature goes down
FUNCTION	OUTPUT VOLTAGE PROGRAMMABLE(PV)	Adjustment of output voltage is allowable to 50 ~ 120% of nominal output voltage Please refer to the Function Manual in following pages
	CONSTANT CURRENT LEVEL PROGRAMMABLE(PC)	Adjustment of constant current level is allowable to 20 ~ 100% of rated current Please refer to the Function Manual in following pages
	REMOTE ON-OFF CONTROL	By electrical signal or dry contact    Power ON:short Power OFF:open. Please refer to the Function Manual in following pages
	CURRENT SHARING	Active current sharing up to 10 rack shelves(DHP-1UT-BHV) and the maximum supply units that can be connected in parallel is 40
	AUXILIARY POWER	5V @ 0.3A, tolerance ±10%, ripple 150mVp-p, 12V @ 0.8A, tolerance ± 10%, ripple 450mVp-p
	ALARM SIGNAL	Isolated TTL signal output for T-Alarm, AC-OK and DC-OK Please refer to the Function Manual in following pages
ENVIRONMENT	WORKING TEMP.	-30 ~ +70°C (Refer to "Derating Curve")
	WORKING HUMIDITY	20 ~ 90% RH non-condensing
	STORAGE TEMP., HUMIDITY	-40 ~ +85°C, 10 ~ 95% RH non-condensing
	TEMP. COEFFICIENT	±0.03%/°C (0 ~ 50°C)
VIBRATION	10 ~ 500Hz, 2G 10min./1cycle, 60min. each along X, Y, Z axes	

SAFETY & EMC (Note.10)	SAFETY STANDARDS	UL62368-1, CSA C22.2 No. 62368-1, TUV BS EN/EN62368-1, EAC TP TC 004 approved ; Design refer to AS/NZS62368.1		
	WITHSTAND VOLTAGE	I/P-O/P:3KVAC    I/P-FG:2KVAC    O/P-FG:1.5KVAC		
	ISOLATION RESISTANCE	I/P-O/P, I/P-FG, O/P-FG:100M Ohms / 500VDC / 25°C / 70% RH		
	EMC EMISSION	Parameter	Standard	Test Level / Note
		Conducted	BS EN/EN55032 (CISPR32)	Class B
		Radiated	BS EN/EN55032 (CISPR32)	Class A
		Harmonic Current	BS EN/EN61000-3-2	Class A
	Voltage Flicker	BS EN/EN61000-3-3	-----	
	EMC IMMUNITY	BS EN/EN55024, BS EN/EN61000-6-2; Design refer to SEMI F47 at 200VAC		
		Parameter	Standard	Test Level / Note
ESD		BS EN/EN61000-4-2	Level 3, 8KV air ; Level 2, 4KV contact	
Radiated		BS EN/EN61000-4-3	Level 3	
EFT / Burst		BS EN/EN61000-4-4	Level 3	
Surge		BS EN/EN61000-4-5	2KV/Line-Line 4KV/Line-Earth	
Conducted		BS EN/EN61000-4-6	Level 3	
Magnetic Field		BS EN/EN61000-4-8	Level 4	
Voltage Dips and Interruptions	BS EN/EN61000-4-11	>95% dip 0.5 periods, 30% dip 25 periods, >95% interruptions 250 periods		
OTHERS	MTBF	510.5K hrs min.    Telcordia SR-332 (Bellcore) ; 45.8K hrs min.    MIL-HDBK-217F (25°C)		
	DIMENSION	325.8*107*41mm (L*W*H)		
	PACKING	2.3Kg/4pcs/10.2Kg/1.09CUFT		

## Specification For Charger Mode (Selectable by PMBus, CANBus or SBP-001)

MODEL		NCP-3200-24	NCP-3200-48	
OUTPUT	BOOST CHARGE VOLTAGE[Vboost](default)	28.8V	57.6V	
	FLOAT CHARGE VOLTAGE[Vfloat](default)	27.6A	55.2A	
	CONSTANT CURRENT(CC)(default)	110A	55A	
	RECOMMENDED BATTERY CAPACITY(AMP HOURS) Note.3	330 ~ 1000Ah	180 ~ 550Ah	
	LEAKAGE CURRENT FROM BATTERY(Typ.)	<1.5mA		
INPUT	VOLTAGE RANGE Note.4	90 ~ 264VAC 127 ~ 400VDC		
	FREQUENCY RANGE	47 ~ 63Hz		
	POWER FACTOR (Typ.)	0.97/230VAC at full load		
	EFFICIENCY (Typ.)	93%	94%	
	AC CURRENT (Typ.) Note.4	17A/230VAC		
	INRUSH CURRENT (Typ.)	COLD START 55A/230VAC		
LEAKAGE CURRENT	<2mA / 230VAC			
PROTECTION	OVER VOLTAGE	31.5 ~ 37.5V	63 ~ 75V	
	OVER TEMPERATURE	Protection type : Shut down o/p voltage, re-power on to recover Shut down O/P voltage, recovers automatically after temperature goes down		
FUNCTION	REMOTE ON-OFF CONTROL	By electrical signal or dry contact Power ON:short Power OFF:open. Please refer to the Function Manual in following pages		
	CURRENT SHARING	Active current sharing up to 10 rack shelves(DHP-1UT-B) and the maximum supply units that can be connected in parallel is 40		
	AUXILIARY POWER	5V @ 0.3A, tolerance ±10%, ripple 150mVp-p, 12V @ 0.8A, tolerance ±10%, ripple 450mVp-p		
	ALARM SIGNAL	Isolated TTL signal output for T-Alarm, AC-OK and DC-OK Please refer to the Function Manual in following pages		
ENVIRON- MENT	WORKING TEMP.	-30 ~ +70°C (Refer to "Derating Curve")		
	WORKING HUMIDITY	20 ~ 90% RH non-condensing		
	STORAGE TEMP., HUMIDITY	-40 ~ +85°C, 10 ~ 95% RH non-condensing		
	TEMP. COEFFICIENT	±0.03%/°C (0 ~ 50°C)		
	VIBRATION	10 ~ 500Hz, 2G 10min./1cycle, 60min. each along X, Y, Z axes		
OTHERS	MTBF	510.5K hrs min. Telcordia SR-332 (Bellcore); 45.8K hrs min. MIL-HDBK-217F (25°C)		
	DIMENSION	325.8*107*41mm (L*W*H)		
	PACKING	2.3Kg,4pcs/10.2Kg/1.09CUFT		
SAFETY & EMC (Note.6)	SAFETY STANDARDS	UL62368-1, CSA C22.2 No. 62368-1, TUV BS EN/EN62368-1, EAC TP TC 004 approved ; Design refer to AS/NZS62368.1		
	WITHSTAND VOLTAGE	I/P-O/P:3KVAC I/P-FG:2KVAC O/P-FG:1.5KVAC		
	ISOLATION RESISTANCE	I/P-O/P, I/P-FG, O/P-FG:100M Ohms / 500VDC / 25°C / 70% RH		
	EMC EMISSION	Parameter	Standard	Test Level / Note
		Conducted	BS EN/EN55032 (CISPR32)	Class B
		Radiated	BS EN/EN55032 (CISPR32)	Class A
		Harmonic Current	BS EN/EN61000-3-2	Class A
		Voltage Flicker	BS EN/EN61000-3-3	----
	EMC IMMUNITY	Parameter	Standard	Test Level / Note
		ESD	BS EN/EN61000-4-2	Level 3, 8KV air ; Level 2, 4KV contact
Radiated		BS EN/EN61000-4-3	Level 3	
EFT / Burst		BS EN/EN61000-4-4	Level 3	
Surge		BS EN/EN61000-4-5	2KV/Line-Line 4KV/Line-Earth	
Conducted		BS EN/EN61000-4-6	Level 3	
Magnetic Field		BS EN/EN61000-4-8	Level 4	
Voltage Dips and Interruptions		BS EN/EN61000-4-11	>95% dip 0.5 periods, 30% dip 25 periods, >95% interruptions 250 periods	
OTHERS	MTBF	510.5K hrs min. Telcordia SR-332 (Bellcore); 45.8K hrs min. MIL-HDBK-217F (25°C)		
	DIMENSION	325.8*107*41mm (L*W*H)		
	PACKING	2.3Kg,4pcs/10.2Kg/1.09CUFT		

## DHP-1UT-B Specification For Power Supply System (Default)

POWER SYSTEM CONFIGURATION	19" RACK SHELF	DHP-1UT-B	
	POWER UNIT	NCP-3200-24*4	NCP-3200-48*4
OUTPUT	OUTPUT VOLTAGE	24V	48V
	MAX. OUTPUT CURRENT	532A	268A
	MAX. OUTPUT POWER Note.4	12768W	12864A
INPUT	VOLTAGE RANGE Note.6	90 ~ 264VAC 127 ~ 400VDC	
	FREQUENCY RANGE	47 ~ 63Hz	
	AC CURRENT (Typ.) per RECTIFIER	17A/230VAC	
	LEAKAGE CURRENT per RECTIFIER Note.8	<2mA / 230VAC	
FUNCTION	OUTPUT VOLTAGE PROGRAMMABLE(PV)	Adjustment of output voltage is allowable to 50 ~ 125% of nominal output voltage Please refer to the Function Manual in following pages	
	CONSTANT CURRENT LEVEL PROGRAMMABLE(PC)	Adjustment of constant current level is allowable to 20 ~ 100% of rated current Please refer to the Function Manual in following pages	
	REMOTE ON-OFF CONTROL	By electrical signal or dry contact ON:short OFF:open Please refer to the Function Manual in following pages	
	REMOTE SENSE	Compensate voltage drop on the load wiring up to 0.5V	
	AUXILIARY POWER	5V @ 0.3A, tolerance ±10%, ripple 150mVp-p, 12V @ 0.8A, tolerance ±10%, ripple 450mVp-p	
ENVIRON- MENT	ALARM SIGNAL	Isolated TTL signal output for T-Alarm, AC-OK and DC-OK	
	WORKING TEMP.	-30 ~ +70°C, when 3 or 4 power units are paralleled in power shelf, highest working temperature shall de-rate to 40°C at full load	
	WORKING HUMIDITY	20 ~ 90% RH non-condensing	
	STORAGE TEMP., HUMIDITY	-40 ~ +85°C, 10 ~ 95% RH non-condensing	
	TEMP. COEFFICIENT	±0.03%/°C (0 ~ 50°C)	
	VIBRATION	10 ~ 500Hz, 2G 10min./1cycle, 60min. each along X, Y, Z axes	

## DHP-1UT-BHV Specification

POWER SYSTEM CONFIGURATION	19" RACK SHELF	DHP-1UT-BHV	
	POWER UNIT	NCP-3200-380*4	
OUTPUT	OUTPUT VOLTAGE	380V	
	MAX. OUTPUT CURRENT	33.6A	
	CURRENT RANGE	0 ~ 38.4A	
	MAX. OUTPUT POWER Note.4	12825.6W	
INPUT	VOLTAGE RANGE Note.6	90 ~ 264VAC 127 ~ 400VDC	
	FREQUENCY RANGE	47 ~ 63Hz	
	AC CURRENT (Typ.) per RECTIFIER	17A/230VAC	
	LEAKAGE CURRENT per RECTIFIER Note.8	<2mA / 230VAC	
	FUNCTION	OUTPUT VOLTAGE PROGRAMMABLE(PV)	Adjustment of output voltage is allowable to 50 ~ 120% of nominal output voltage Please refer to the Function Manual in following pages
CONSTANT CURRENT LEVEL PROGRAMMABLE(PC)	Adjustment of constant current level is allowable to 20 ~ 100% of rated current Please refer to the Function Manual in following pages		
REMOTE ON-OFF CONTROL	By electrical signal or dry contact ON:short OFF:open. Please refer to the Function Manual in following pages		
AUXILIARY POWER	5V @ 0.3A, tolerance ±10%, ripple 150mVp-p, 12V @ 0.8A, tolerance ±10%, ripple 450mVp-p		
ALARM SIGNAL	Isolated TTL signal output for T-Alarm, AC-OK and DC-OK		
ENVIRON- MENT	WORKING TEMP.	-30 ~ +70°C, when 3 or 4 power units are paralleled in power shelf, highest working temperature shall de-rate to 40°C at full load	
	WORKING HUMIDITY	20 ~ 90% RH non-condensing	
	STORAGE TEMP., HUMIDITY	-40 ~ +85°C, 10 ~ 95% RH non-condensing	
	TEMP. COEFFICIENT	±0.03%/°C (0 ~ 50°C)	
	VIBRATION	10 ~ 500Hz, 2G 10min./1cycle, 60min. each along X, Y, Z axes	

SAFETY & EMC (Note.9)	<b>SAFETY STANDARDS</b>	UL62368-1, CSA C22.2 No. 62368-1, TUV BS EN/EN62368-1, EAC TP TC 004 approved ; Design refer to AS/NZS62368.1		
	<b>WITHSTAND VOLTAGE</b>	I/P-O/P:3KVAC I/P-FG:2KVAC O/P-FG:1.5KVDC		
	<b>ISOLATION RESISTANCE</b>	I/P-O/P, I/P-FG, O/P-FG:100M Ohms / 500VDC / 25°C / 70% RH		
	<b>EMC EMISSION</b>	<b>Parameter</b>	<b>Standard</b>	<b>Test Level / Note</b>
		Conducted	BS EN/EN55032 (CISPR32)	Class B
		Radiated	BS EN/EN55032 (CISPR32)	Class A
		Harmonic Current	BS EN/EN61000-3-2	Class A
	Voltage Flicker	BS EN/EN61000-3-3	----	
	<b>EMC IMMUNITY</b>	BS EN/EN55024, BS EN/EN61000-6-2		
		<b>Parameter</b>	<b>Standard</b>	<b>Test Level / Note</b>
ESD		BS EN/EN61000-4-2	Level 3, 8KV air ; Level 2, 4KV contact	
Radiated		BS EN/EN61000-4-3	Level 3	
EFT / Burst		BS EN/EN61000-4-4	Level 3	
Surge		BS EN/EN61000-4-5	Level 4, 2KV/Line-Line 4KV/Line-Earth	
Conducted		BS EN/EN61000-4-6	Level 3	
Magnetic Field		BS EN/EN61000-4-8	Level 4	
Voltage Dips and Interruptions	BS EN/EN61000-4-11	>95% dip 0.5 periods, 30% dip 25 periods, >95% interruptions 250 periods		
OTHERS	<b>MTBF</b>	3698.9K hrs min. Telcordia SR-332 (Bellcore) ; 818.3K hrs min. MIL-HDBK-217F (25°C)		
	<b>DIMENSION</b>	Rack 400*482.6*44(L*W*H, with mounting bracket) ; 400*440*44(L*W*H, without mounting bracket)		
	<b>PACKING</b>	4.76Kg; 3pcs/17.4Kg/3.3UFT		

DHP-1UT-B Specification For Charger System (Selectable by PMBus, CANBus or SBP-001)

CHARGER SYSTEM CONFIGURATION	19" RACK SHELF	DHP-1UT-B		
	CHARGER UNIT	NCP-3200-24*4	NCP-3200-48*4	
OUTPUT	BOOST CHARGE VOLTAGE[Vboost](default)	28.8V	57.6V	
	FLOAT CHARGE VOLTAGE[Vfloat](default)	27.6V	55.2V	
	CURRENT RANGE	0 ~ 440A	0 ~ 220A	
INPUT	<b>VOLTAGE RANGE</b> <small>Note.2</small>	90 ~ 264VAC 127 ~ 400VDC		
	<b>FREQUENCY RANGE</b>	47 ~ 63Hz		
	<b>AC CURRENT (Typ.) per CHARGER</b>	17A/230VAC		
	<b>LEAKAGE CURRENT per CHARGER</b> <small>Note.4</small>	<2mA / 230VAC		
FUNCTION	<b>REMOTE ON-OFF CONTROL</b>	By electrical signal or dry contact ON:short OFF:open Please refer to the Function Manual in following pages		
	<b>AUXILIARY POWER</b>	5V @ 0.3A, tolerance ± 10%, ripple 150mVp-p, 12V @ 0.8A, tolerance ± 10%, ripple 450mVp-p		
	<b>ALARM SIGNAL</b>	Isolated TTL signal output for T-Alarm, AC-OK and DC-OK. Please refer to Installation Manual		
ENVIRONMENT	<b>WORKING TEMP.</b>	-30 ~ +70°C, when 3 or 4 charger units are paralleled in power shelf, highest working temperature shall de-rate to 40°C at full load		
	<b>WORKING HUMIDITY</b>	20 ~ 90% RH non-condensing		
	<b>STORAGE TEMP., HUMIDITY</b>	-40 ~ +85°C, 10 ~ 95% RH non-condensing		
	<b>TEMP. COEFFICIENT</b>	±0.03%/°C (0 ~ 50°C)		
	<b>VIBRATION</b>	10 ~ 500Hz, 2G 10min./1cycle, 60min. each along X, Y, Z axes		
SAFETY & EMC (Note.6)	<b>SAFETY STANDARDS</b>	UL62368-1, TUV BS EN/EN62368-1, EAC TP TC 004 approved		
	<b>WITHSTAND VOLTAGE</b>	I/P-O/P:3KVAC I/P-FG:2KVAC O/P-FG:1.5KVDC		
	<b>ISOLATION RESISTANCE</b>	I/P-O/P, I/P-FG, O/P-FG:100M Ohms / 500VDC / 25°C / 70% RH		
	<b>EMC EMISSION</b>	<b>Parameter</b>	<b>Standard</b>	<b>Test Level / Note</b>
		Conducted	BS EN/EN55032 (CISPR32)	Class B
		Radiated	BS EN/EN55032 (CISPR32)	Class A
		Harmonic Current	BS EN/EN61000-3-2	Class A
	Voltage Flicker	BS EN/EN61000-3-3	----	
	<b>EMC IMMUNITY</b>	BS EN/EN55024, BS EN/EN61000-6-2		
		<b>Parameter</b>	<b>Standard</b>	<b>Test Level / Note</b>
ESD		BS EN/EN61000-4-2	Level 3, 8KV air ; Level 2, 4KV contact	
Radiated		BS EN/EN61000-4-3	Level 3	
EFT / Burst		BS EN/EN61000-4-4	Level 3	
Surge		BS EN/EN61000-4-5	Level 4, 2KV/Line-Line 4KV/Line-Earth	
Conducted		BS EN/EN61000-4-6	Level 3	
Magnetic Field		BS EN/EN61000-4-8	Level 4	
Voltage Dips and Interruptions	BS EN/EN61000-4-11	>95% dip 0.5 periods, 30% dip 25 periods, >95% interruptions 250 periods		
OTHERS	<b>MTBF</b>	3698.9K hrs min. Telcordia SR-332 (Bellcore) ; 818.3K hrs min. MIL-HDBK-217F (25°C)		
	<b>DIMENSION</b>	Rack 400*482.6*44(L*W*H, with mounting bracket) ; 400*440*44(L*W*H, without mounting bracket)		
	<b>PACKING</b>	4.76Kg; 3pcs/17.4Kg/3.3UFT		

\*For detailed Note information, please refer to the specifications on MEAN WELL official website

### 2.4 Static Characteristics

⊙ When the AC power input is low, the output overcurrent protection will automatically derate, as shown in the figure below.

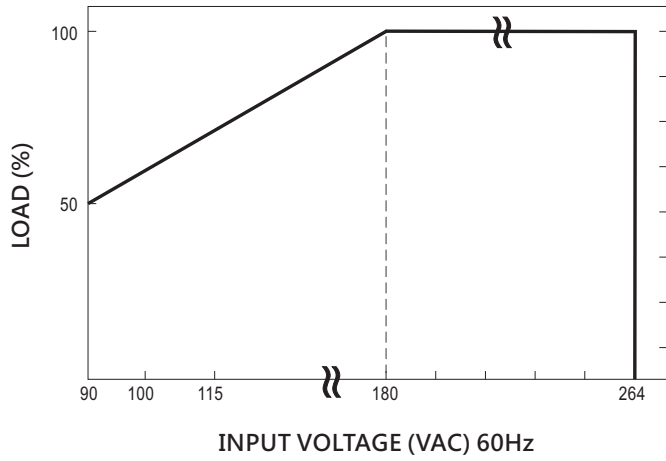

### 2.5 Derating Curve

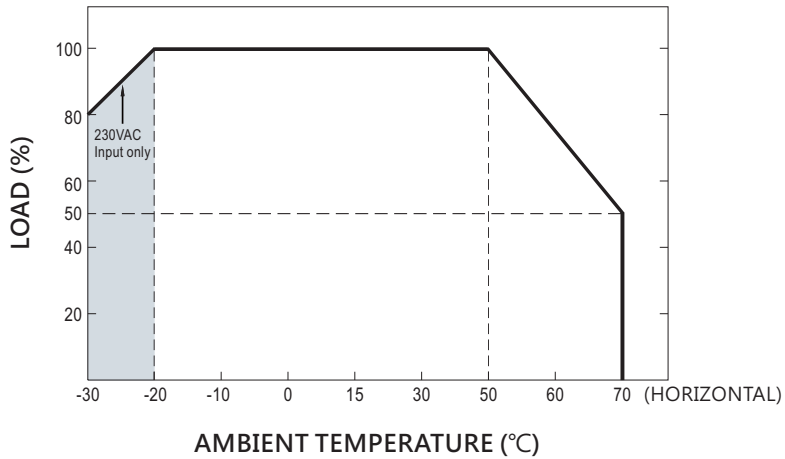

### 2.6 Mechanical Specification

⊙ NCP-3200

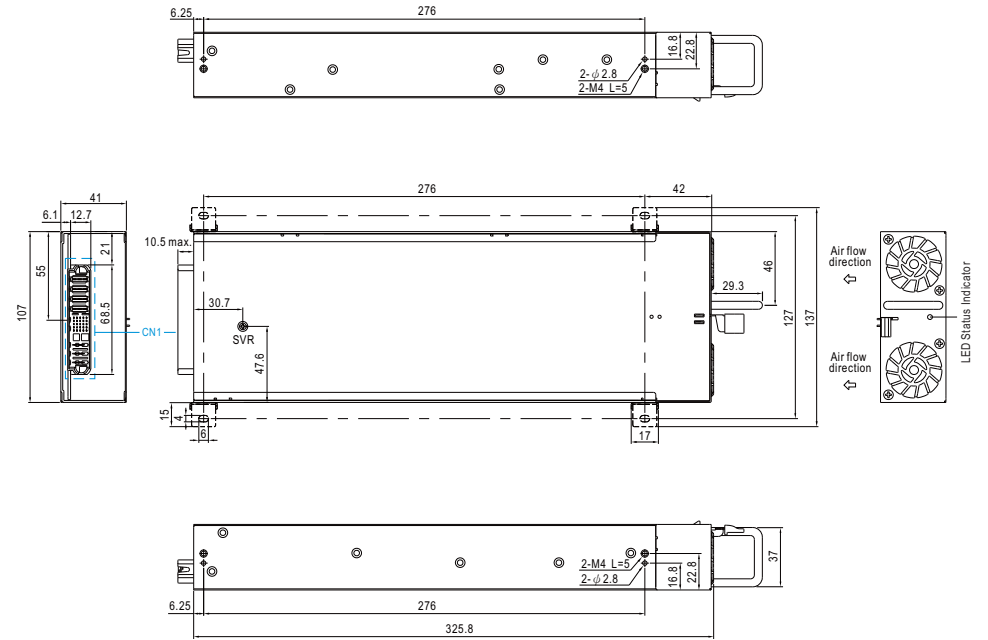

◎ DHP-1UT-B(HV)

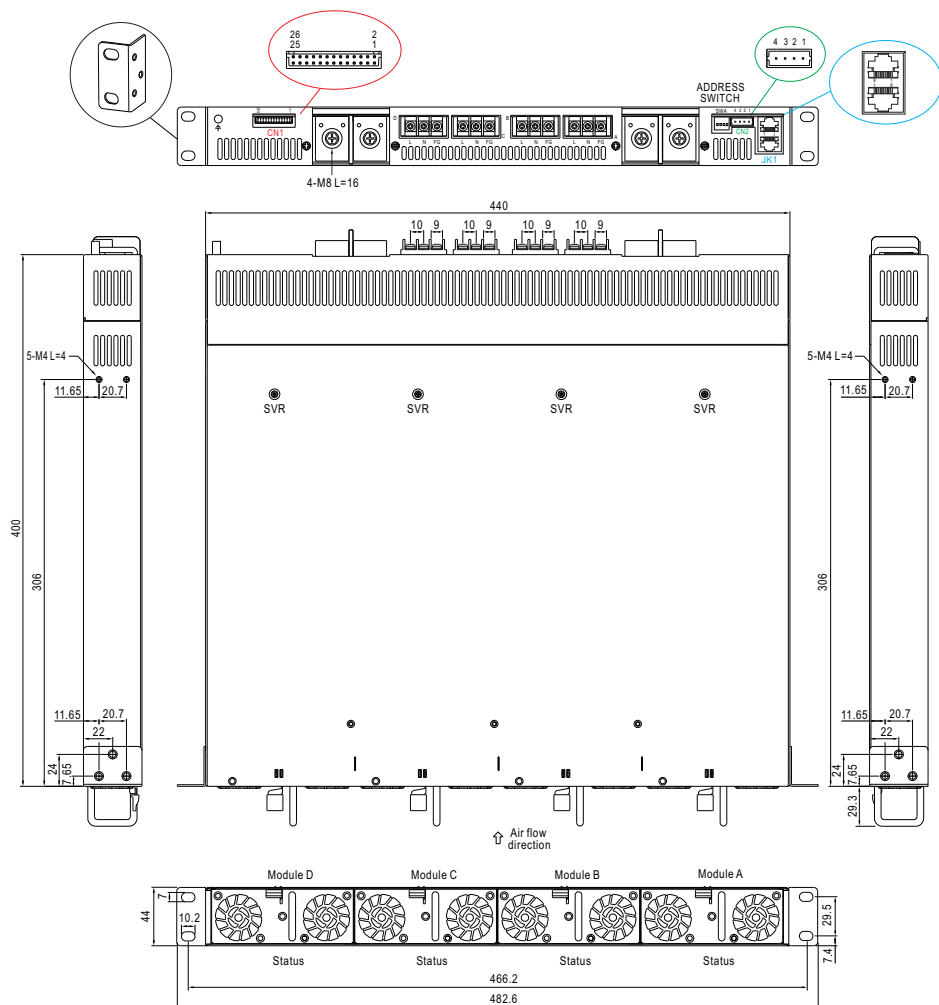

## 3. Installation & Wiring

### 3.1 Precautions

- DHP-1UT-B is designed to be used with SELV (Safety Extra Low Voltage) and is only compatible with NCP-3200-24/48. If your application is for NCP-3200-380, please select DHP-1UT-BHV to prevent damage to the low voltage rack shelf.
- The rack shelf should be mounted and secured onto the 19-inch rack before installing rack power supplies.
- Insert 1- 4 units of the NCP-3200 power supplies with identical output voltage and current into the DHP-1UT-B(HV) rack shelf (as illustrated in Figure 3-1)
- The rack power supply is designed with built-in DC fans, please make sure the ventilation is not blocked. There should be no barriers within 10cm of the ventilating.
- Connect the AC mains to the AC input terminals (A, B, C, D) of the rack shelf for the NCP-3200 devices.

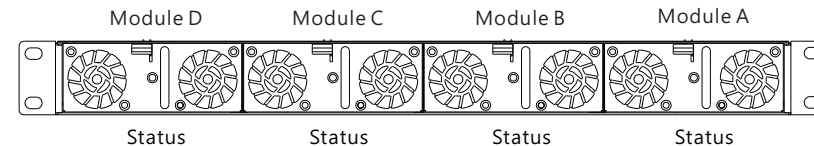

Figure 3-1 Installation of DHP-1UT-B(HV)

### 3.2 Hot Swapping (with DHP-1UT-B(HV))

- Built-in "Oring MOSFETs", the units can be installed/ removed without turning power off.
- Insert units: Grasp the handle and push into the rack shelf through the rail.

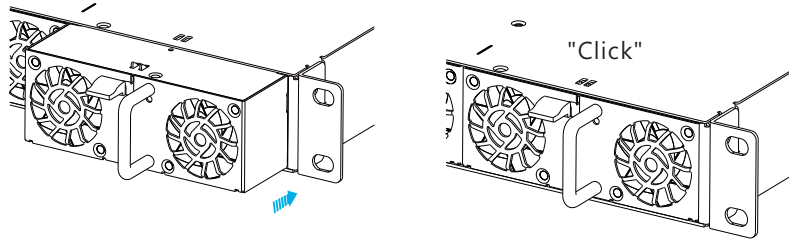

Figure 3-2 Illustration of how to insert the NCP-3200 into a DHP-1UT-B(HV)

- Pull out units: Press the clip shown in Figure 3-3 and pull it out.

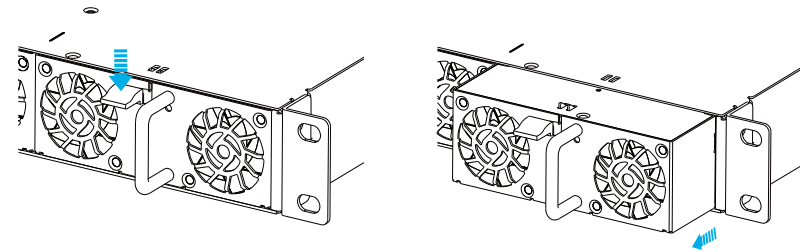

Figure 3-3 Illustration of how to remove NCP-3200 from a DHP-1UT-B(HV)

**NOTE:**

1. Please use adequate force to insert the rack supplies into the rack shelf. Slamming rack supplies into the rack shelf can damage the connectors both on the rear of the supplies and inside the rack shelf.
2. The DHP-1UT-B rack shelf is designed for the NCP-3200-24/48 models and is not compatible with the high voltage DC version of the NCP-3200-380. Attempting to install a high voltage DC supply into a low voltage rack shelf will result in damage to the low voltage rack shelf.
3. For hot-swapping multiple units of rack supplies into/from the rack shelf, the interval between inserting/removing procedures should be longer than 1 second.

19" rack shelf	DHP-1UT-B	DHP-1UT-B	DHP-1UT-BHV
Power supply or charger unit	NCP-3200-24*4	NCP-3200-48*4	NCP-3200-380*4

### 3.3 Wiring

1. Choose the right and suitable cable size for connection between the DHP-1UT-B(HV) and the loads/batteries. Please refer to 3.4 DC cable size selection.
2. Connect the DC positive polarity of the rack shelf to the positive of the loads/batteries and connect the DC negative polarity of the rack shelf to the negative of loads/batteries. Make sure there is no reverse polarity or short-circuit on the connection.

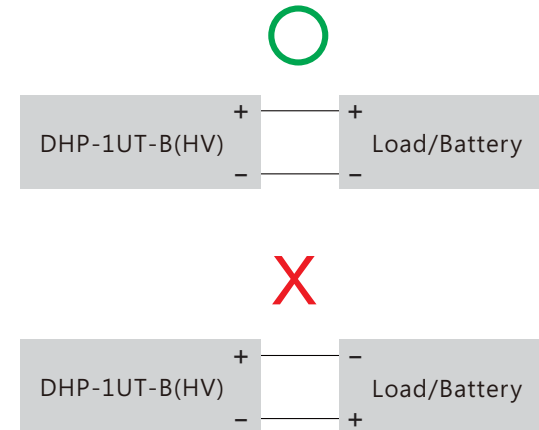

3. Connect the AC input of the rack shelf to the AC grid, FG to the earth, AC/N to the neutral and AC/L to the live.

### 3.4 Cable Size Selection

Cable connections should be as short as possible and make sure that suitable cables are chosen based on safety requirement and rating of current. Small cross section will result in lower efficiency, less output power and the cables may also become overheated and cause danger. For selection, please refer to table 3-1.

Table 3-1 cable recommendations

Input/ Output	Model	Current	Minimum Cross-section of copper wire	Maximum Current
115VAC	1 unit	9Arms	14AWG	16A
230VAC	1 unit	17Arms	12AWG	25A
+24VDC	1 unit	133Adc	30mm <sup>2</sup>	139A
	2 unit	266Adc	100mm <sup>2</sup>	298A
	3 unit	399Adc	200mm <sup>2</sup>	469A
	4 unit	532Adc	250mm <sup>2</sup>	556A
+48VDC	1 unit	67Adc	22mm <sup>2</sup>	115A
	2 unit	134Adc	30mm <sup>2</sup>	139A
	3 unit	201Adc	60mm <sup>2</sup>	217A
	4 unit	268Adc	100mm <sup>2</sup>	298A
+380VDC	1 unit	8.4Adc	16AWG	10A
	2 unit	16.8Adc	12AWG	25A
	3 unit	25.2Adc	10AWG	32A
	4 unit	33.6Adc	8AWG	40A
Other commonly used wires			16AWG	10A
			12AWG	25A
			10AWG	32A
			30mm <sup>2</sup>	139A
			50mm <sup>2</sup>	190A
			60mm <sup>2</sup>	217A
			80mm <sup>2</sup>	257A
			100mm <sup>2</sup>	298A
			125mm <sup>2</sup>	344A
			150mm <sup>2</sup>	395A
			200mm <sup>2</sup>	469A
			250mm <sup>2</sup>	556A
		325mm <sup>2</sup>	665A	

### 4. Panel and LED indicator

#### 4.1 NCP-3200 Panel Description

- Ⓐ LED indicator:  
Indicate the status of the supply and load condition.
- Ⓑ Input/output Connector (CN1):  
In addition to connecting AC input and DC output, it also includes control and communication signal transmission. For more detailed information, please refer to section 4.1.1.
- Ⓒ SVR:  
Used to adjust output voltage.
- Ⓓ Clip:  
Designed for locking position with the rack shelf.
- Ⓔ Handle

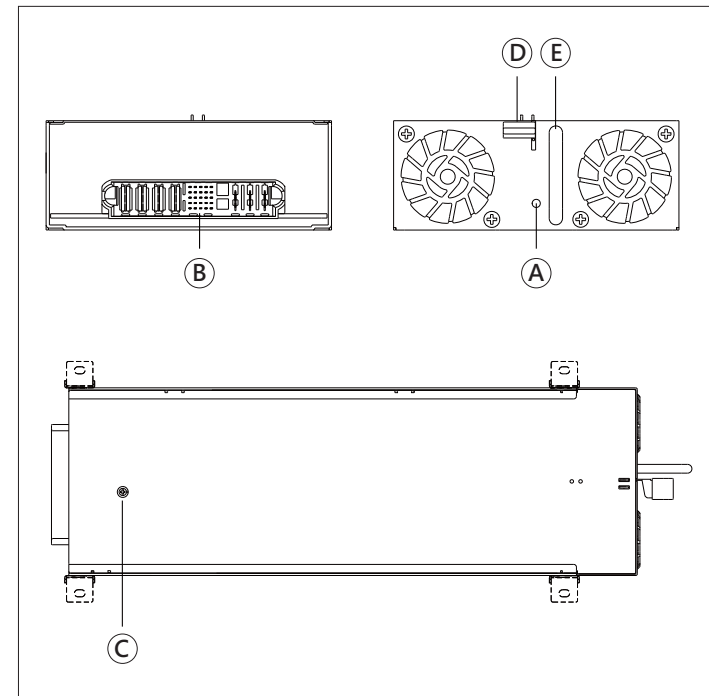

#### 4.1.1 Input / Output Connector Pin No. Assignment CN1

© NCP-3200

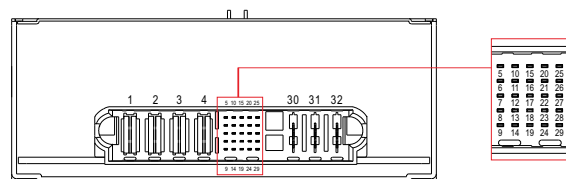

Input / Output Connector	ALLTOP C27309-10749-Y
Mating Housing	ALLTOP C27209-10749-Y

Pin No.	Function	Description
1,2	-V	Negative output terminal
3,4	+V	Positive output terminal
5	+12V-AUX	Auxiliary voltage output, 10.8~13.2V, referenced to GND-AUX (pin 7). The maximum load current is 0.8A. This output has the built-in "Oring diodes" and is not controlled by the Remote ON/OFF control.
6	+5V-AUX	Auxiliary voltage output, 4.5~5.5V, reference to GND_AUX(pin7). The maximum load current is 0.3A. The output has the built-in "Oring diodes" and is not controlled by the Remote ON/OFF control.
7	GND-AUX	Auxiliary voltage output GND. The signal return is isolated from the output terminals (+V & -V).
8	AC-OK	High (3.5 ~ 5.5V) : When the input voltage is $\geq 87$ Vrms. Low (-0.5 ~ 0.5V) : When the input voltage is $\leq 75$ Vrms. The maximum sourcing current is 10mA and only for output. (Note.2)
9	T-ALARM	High (3.5 ~ 5.5V) : When the internal temperature exceeds the limit of temperature alarm, or when fan fails. Low (-0.5 ~ 0.5V) : When the internal temperature is normal, and when fan normally works. The maximum sourcing current is 10mA and only for output(Note.2)
10,24	NC	Standard model: Retain for future use
11	SCL	For PMBus model: Serial Clock used in the PMBus interface. (Note.2)
	CANL	For CANBus model: Data line used in CANBus interface. (Note.2)
12	SDA	For PMBus model: Serial Data used in the PMBus interface. (Note.2)
	CANH	For CANBus model: Data line used in CANBus interface. (Note.2)
13	Remote ON-OFF	The unit can turn the output ON/OFF by electrical signal or dry contact between Remote ON/OFF and +5V-AUX. (Note.2) Short (4.5 ~ 5.5V) : Power ON ; Open (-0.5 ~ 0.5V) : Power OFF ; The maximum input voltage is 5.5V.

Pin No.	Function	Description
14	DC-OK	For power supply mode High (3.5 ~ 5.5V) : When the $V_{out} \leq 77\% \pm 5\%$ . Low (-0.5 ~ 0.5V) : When the $V_{out} \geq 80\% \pm 5\%$ . The maximum sourcing current is 10mA and only for output. (Note.2)
		For charger mode High (3.5 ~ 5.5V) : When the $V_{out} \leq 66\% \pm 5\%$ . Low (-0.5 ~ 0.5V) : When the $V_{out} \geq 67\% \pm 5\%$ . The maximum sourcing current is 10mA and only for output. (Note.2) DC OK is associated with battery low protection.
15,16	DA,DB	Differential digital signal for parallel control. (Note.1)
17	PC	Connection for constant current level programming. (Note.1)
18,19,20,21	A2,A3,A4,A5	PMBus / CANBus interface address lines(for Rack system). (Note.1)
22,23	A0,A1	PMBus / CANBus interface address lines for Rack mountable front end rectifier. (Note.1)
25	PV	Connection for output voltage programming. (Note.1)
26	-V (Signal)	Negative output voltage signal. It is for local sense; and certain function reference; it cannot be connected directly to the load.
27	-S	Negative sensing for remote sense.(For 24V/48V models under power supply mode only)
	NC	Not available for NCP-3200-380
28	+S	Positive sensing for remote sense. (For 24V/48V models under power supply mode only)
	NC	Not available for NCP-3200-380
29	-V (Signal)	Positive output voltage signal.(For 24V/48V models under power supply mode only) It is for local sense; it cannot be connected directly to the load.
	NC	Not available for NCP-3200-380
30	FG	AC Ground connection.
31	AC/N	AC Neutral connection.
32	AC/L	AC Line connection.

Note1: Non-isolated signal, referenced to [-V(signal)].

Note2: Isolated signal, referenced to GND-AUX

## 4.2 DHP-1UT-B(HV) Panel Description

- A AC input terminals(AC/L, AC/N,  $\oplus$ )**  
Recommended cable size: 14~18AWG ; Recommended torque:14 kgf-cm.
- B DC output terminals( $\pm$ V)**  
Recommended cable size: minimum 14AWG ; Recommended torque: 35 kgf-cm.
- C Address setting switch (SWA):**  
Used for device addressing when communication interface is used, please refer to section 4.4.
- D Function port(CN1):**  
Used for control and status monitoring, please refer to section 4.2.1 for details.
- E Voltage drop compensation port (CN2):**  
Used for Voltage drop compensation, please refer to section 4.2.2 for details.
- F Communication port(JK1):**  
Used for communication with PMBus, CANBus or SBP-001, please refer to section 4.2.3 for details.
- G SVR:**  
Used to adjust each output voltage.

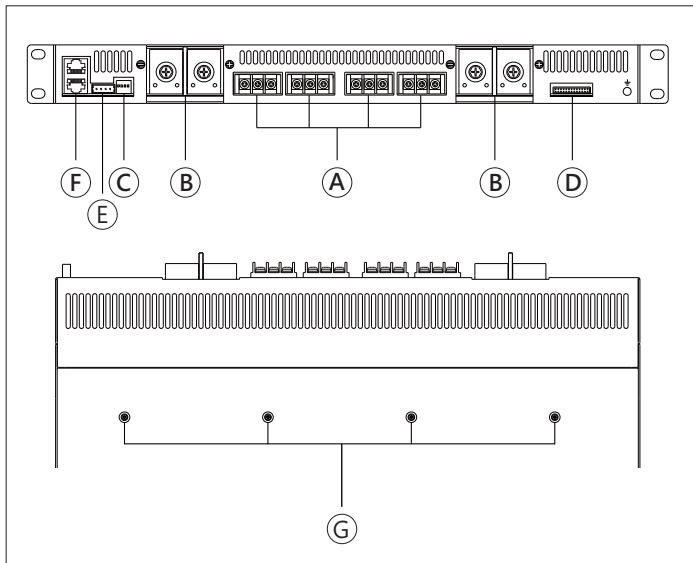

### 4.2.1 Connector Pin No. Assignment CN1:



1	Remote ON-OFF	AC-OK	Remote ON-OFF	AC-OK	Remote ON-OFF	AC-OK	Remote ON-OFF	NC	NC	+5V-AUX	+12V-AUX	PC	25
2	DC-OK	T-ALARM	DC-OK	T-ALARM	DC-OK	T-ALARM	DC-OK	NC	NC	GND-AUX	-V(Signal)	PV	26

Pin No.	Function	Description
1,5,9,13	AC-OK	High (3.5 ~ 5.5V) : When the input voltage is $\geq 87$ Vrms. Low (-0.5 ~ 0.5V) : When the input voltage is $\leq 75$ Vrms. The maximum sourcing current is 10mA and only for output. (Note.2)
2,6,10,14	DC-OK	For power supply system High (3.5 ~ 5.5V) : When the Vout $\leq 77\% \pm 5\%$ . Low (-0.5 ~ 0.5V) : When Vout $\geq 80\% \pm 5\%$ . The maximum sourcing current is 10mA and only for output. (Note.2)  For charger system High (3.5 ~ 5.5V) : When the Vout $\leq 66\% \pm 5\%$ . Low (-0.5 ~ 0.5V) : When Vout $\geq 67\% \pm 5\%$ . The maximum sourcing current is 10mA and only for output. (Note.2) DC OK is associated with battery low protection.
3,7,11,15	Remote ON-OFF	The unit can turn the output ON/OFF by electrical signal or dry contact between Remote ON-OFF and +5V-AUX. (Note.2) Short (4.5 ~ 5.5V) : Power ON ; Open (-0.5 ~ 0.5V) : Power OFF ; The maximum input voltage is 5.5V.
4,8,12,16	T-ALARM	High (3.5 ~ 5.5V) : When the internal temperature exceeds the limit of temperature alarm, or when fan fails. Low (-0.5 ~ 0.5V) : When the internal temperature is normal, and when fan normally works. The maximum sourcing current is 10mA and only for output(Note.2)
17,18,19,20	NC	Retain for future use.
21	+5V-AUX	Auxiliary voltage output,4.5~5.5V, reference to GND_AUX(pin22).The maximum load current is 0.3A.
22	GND-AUX	Auxiliary voltage output GND. The signal return is isolated from the output terminals (+V & -V).
23	+12V-AUX	Auxiliary voltage output, 10.8~13.2V, referenced to GND-AUX (pin 22). The maximum load current is 0.8A. This output has the built-in "Oring diodes" and is not controlled by the remote ON/OFF control.
24	-V(Signal)	Negative output voltage. For local sense use only; It can't be connected directly to the load.
25	PC	Connection for output current programming. The current can be trimmed within its defined range. (Note.1)
26	PV	Connection for output voltage programming. The voltage can be trimmed within its defined range. (Note.1)

Note.1: Non-isolated signal, referenced to [-V(signal)].

Note.2: Isolated signal, referenced to GND-AUX.

#### 4.2.2 Connector Pin No. Assignment CN2:

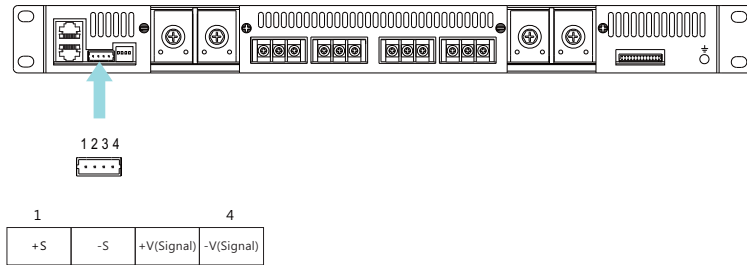

© For 24V/48V models under power supply system only

Pin No.	Function	Description
1	+S	Positive sensing. The +S signal should be connected to the positive terminal of the load. The +S and -S leads should be twisted in pair to minimize noise pick-up effect. The maximum line drop compensation is 0.5V.
2	-S	Negative sensing. The -S signal should be connected to the negative terminal of the load. The -S and +S leads should be twisted in pair to minimize noise pick-up effect. The maximum line drop compensation is 0.5V.
3	+V(Signal)	Positive output voltage. For local sense use only, can't be connected directly to the load.
4	-V(Signal)	Negative output voltage. For local sense use only, can't be connected directly to the load.

#### 4.2.3 Connector Pin No. Assignment JK1:

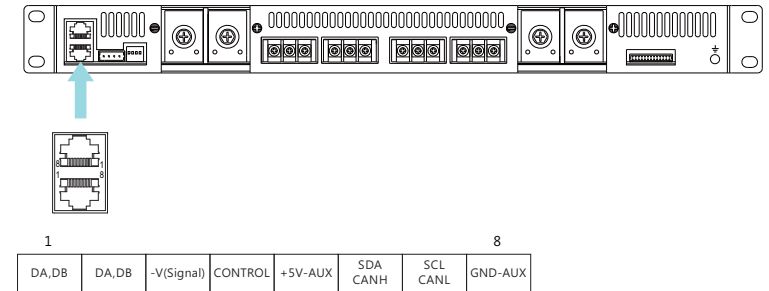







Pin No.	Function	Description
1,2	DA, DB	Differential digital signal for parallel control. (Note.1)
3	-V(Signal)	Negative output voltage signal. It is for local sense and certain function reference; it cannot be connected directly to the load.
4	CONTROL	Remote ON-OFF control pin used in the PMBus interface. (Note.2)
5	+5V-AUX	+5V-AUX pin used in the PMBus interface (Note.2)
6	SDA	For PMBus model: Serial Data used in the PMBus interface. (Note.2)
	CANH	For CANBus model: Data line used in CANBus interface. (Note.2)
7	SCL	For PMBus model: Serial Clock used in the PMBus interface. (Note.2)
	CANL	For CANBus model: Data line used in CANBus interface. (Note.2)
8	GND-AUX	Auxiliary voltage output GND. The signal return is isolated from the output terminals (+V & -V).

Note.1: Non-isolated signal, referenced to [-V(signal)].

Note.2: Isolated signal, referenced to GND-AUX.

### 4.3 LED indicator

Power Supply Mode	
LED	Description
Green 	The power supply functions normally
Red 	The LED will present a constant red light when the abnormal status (OTP, OLP, fan fail) arises
Red (Flashing) 	The LED will flash in red when the internal temperature reaches 60°C. Under this condition, the unit still operates normally without entering OTP. In the meantime, an alarm signal can be read via PMBus/ CANBus interface.)

Charger Mode	
LED	Description
Green 	Float (stage 3)
Orange 	Charging (stage 1 or stage 2)
Red 	The LED will present a constant red light when the abnormal status (OTP, OLP, fan fail and charging timeout) arises
Red (Flashing) 	The LED will flash in red when the internal temperature reaches 60°C. Under this condition, the unit still operates normally without entering OTP. In the meantime, an alarm signal can be read via PMBus/ CANBus interface.)

### 4.4 Communication Address/ID Assignment

When using PMBus or CANBus communication, each NCP-3200 unit must be set with a unique and non-duplicate device address or ID, a total of 64 addresses or IDs can be assigned. It's important to note that the setting is different between a single unit and the whole rack shelf. Please refer to the following instructions for address/ID assignment.

- Single unit: NCP-3200

A5 - A0 can be used to designate an address and is able to be set and changed by PIN18 - PIN23 of CN1. An open circuit represents logic "1"; while a short circuit with -V(Signal) (PIN26) means logic "0".

Address or ID	A5	A4	A3	A2	A1	A0
0	0	0	0	0	0	0
1	0	0	0	0	0	1
2	0	0	0	0	1	0

Address or ID	A5	A4	A3	A2	A1	A0
3	0	0	0	0	1	1
4	0	0	0	1	0	0
5	0	0	0	1	0	1
6	0	0	0	1	1	0
7	0	0	0	1	1	1
8	0	0	1	0	0	0
9	0	0	1	0	0	1
10	0	0	1	0	1	0
11	0	0	1	0	1	1
12	0	0	1	1	0	0
13	0	0	1	1	0	1
14	0	0	1	1	1	0
15	0	0	1	1	1	1
16	0	1	0	0	0	0
17	0	1	0	0	0	1
18	0	1	0	0	1	0
19	0	1	0	0	1	1
20	0	1	0	1	0	0
21	0	1	0	1	0	1
22	0	1	0	1	1	0
23	0	1	0	1	1	1
24	0	1	1	0	0	0
25	0	1	1	0	0	1
26	0	1	1	0	1	0
27	0	1	1	0	1	1
28	0	1	1	1	0	0
29	0	1	1	1	0	1
30	0	1	1	1	1	0
31	0	1	1	1	1	1
32	1	0	0	0	0	0
33	1	0	0	0	0	1
34	1	0	0	0	1	0
35	1	0	0	0	1	1
36	1	0	0	1	0	0
37	1	0	0	1	0	1
38	1	0	0	1	1	0
39	1	0	0	1	1	1
40	1	0	1	0	0	0
41	1	0	1	0	0	1
42	1	0	1	0	1	0
43	1	0	1	0	1	1

Address or ID	A5	A4	A3	A2	A1	A0
44	1	0	1	1	0	0
45	1	0	1	1	0	1
46	1	0	1	1	1	0
47	1	0	1	1	1	1
48	1	1	0	0	0	0
49	1	1	0	0	0	1
50	1	1	0	0	1	0
51	1	1	0	0	1	1
52	1	1	0	1	0	0
53	1	1	0	1	0	1
54	1	1	0	1	1	0
55	1	1	0	1	1	1
56	1	1	1	0	0	0
57	1	1	1	0	0	1
58	1	1	1	0	1	0
59	1	1	1	0	1	1
60	1	1	1	1	0	0
61	1	1	1	1	0	1
62	1	1	1	1	1	0
63	1	1	1	1	1	1

EX: When CN1's A0 (PIN22) and A1 (PIN23) are short-circuited with -V (Signal) (PIN26) and the other A2 (PIN18) - A5 (PIN21) are remained open, it indicates that the address or CAN ID of the NCP unit is "60".

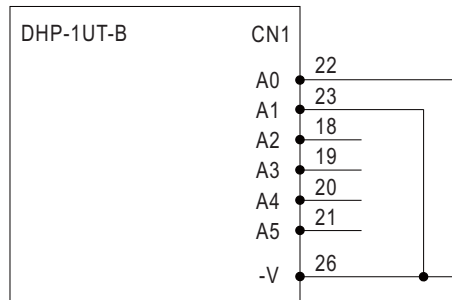

● Whole rack shelf: DHP-1UT-B(HV)

When NCP-3200 units are installed inside a DHP-1UT-B(HV) rack shelf, A0-A1 for each single unit in the rack shelf is assigned automatically according to the module positions. Users can set a rack number or A2 – A5 for the rack supplies through the SWA DIP switch on the rear of DHP-1UT-B(HV). Please refer to the following table for the actual coding. The SWA setting shows different positions of the DIP switch and the numbers in blue represent the PMBus address or CANBus ID for the NCP units.

User defined				Assigned by rack	
A5(SWA-4)	A4(SWA-3)	A3(SWA-2)	A2(SWA-1)	A1 (fixed)	A0 (fixed)

Rack No.	SWA Setting				Address or ID			
	1	2	3	4	Module D	Module C	Module B	Module A
0	ON	ON	ON	ON	3	2	1	0
1	OFF	ON	ON	ON	7	6	5	4
2	ON	OFF	ON	ON	11	10	9	8
3	OFF	OFF	ON	ON	15	14	13	12
4	ON	ON	OFF	ON	19	18	17	16
5	OFF	ON	OFF	ON	23	22	21	20
6	ON	OFF	OFF	ON	27	26	25	24
7	OFF	OFF	OFF	ON	31	30	29	28
8	ON	ON	ON	OFF	35	34	33	32
9	OFF	ON	ON	OFF	39	38	37	36
10	ON	OFF	ON	OFF	43	42	41	40
11	OFF	OFF	ON	OFF	47	46	45	44
12	ON	ON	OFF	OFF	51	50	49	48
13	OFF	ON	OFF	OFF	55	54	53	52
14	ON	OFF	OFF	OFF	59	58	57	56
15	OFF	OFF	OFF	OFF	63	62	61	60

EX: To designate an address or CAN ID to "0" for a unit, you have to install the unit in the far right slot or module A and set the SWA DIP switch to ON/ON/ON/ON positions.

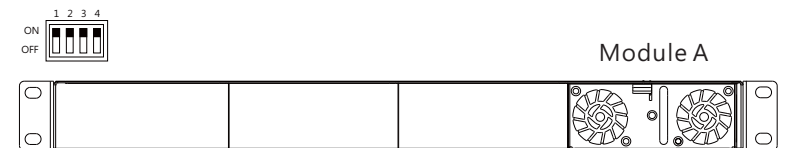

DHP-1UT-B(HV)

## 5.Operation

### 5.1 Input Voltage Range

- The input voltage range is AC90~264V or DC127~400V.
- To insure proper operation, AC input should be within the pre-specified range. A wrong input voltage will cause the supply/ charger operating improperly, losing PFC function or even damaging the units in worst case scenario.
- The efficiency will be lower and the output current will be automatically limited to a predetermined safe value if the units are applied with a lower input voltage. Please refer 2.4 Static Characteristics to for more information.

### 5.2 Inrush Current Limiting

- Built-in inrush current limiting circuit.
- Since the inrush limiting circuit mainly consists of a thermistor and a relay, inrush current will be much higher than the specified value if input thermistor is not allowed sufficient time to cool down.  
After turning off the supplies/chargers, a 10 second cool down period is recommended before turning them on again.

### 5.3 Output Power

◎ Single unit (default setting)

	Power supply mode	Charger mode
NCP-3200-24	3192W(24V/133A)	3168W(28.8V/110A)
NCP-3200-48	3216W(48V/67A)	3168W(57.6V/55A)
NCP-3200-380	3192W(380V/8.4A)	---

◎ Whole rack shelf (default setting)

	Power supply mode	Charger mode
DHP-1UT-B + NCP-3200-24*4pcs	12768W(24V/532A)	12672W(28.8V/440A)
DHP-1UT-B + NCP-3200-48*4pcs	12864W(48V/268A)	12672W(57.6V/220A)
DHP-1UT-BHV + NCP-3200-380*4pcs	12768W(380V/33.6A)	-----

### 5.4 Power Factor Correction (PFC)

- Built-in active power factor correction (PFC) function, power factor (PF) will be 0.97 or better when the input voltage is in a range of 90 -230Vac and operated at full load condition. PF will be less than 0.97 if the output is not at full load or the input voltage is higher than 230Vac.

### 5.5 Output Voltage Adjustment

- Output voltage can be adjusted via SVR, PV or communication interface.

#### 5.5.1 SVR

Output voltage can be trimmed by adjusting SVR (which can be found under the small circular hole, located on the top of the unit). Please utilize an isolated cross-head screwdriver to make an adjustment.

#### 5.5.2 PV (Output Voltage Programming)

Output voltage of NCP-3200 in a DHP-1UT-B(HV) can be adjusted at the same time via a 0-5V DC source. Adjustable voltage range is 50~125% for 24/48V models and 50~120% for 380V model.

- 1.Connect output of the external DC source to PV(26) and -V(24) on CN1, as shown in Figure 5-1.
- 2.Relationship between output voltage and external DC source is shown in Figure 5-2.
- 3.When increasing the output to a higher voltage level, please reduce the loading current accordingly. Output wattage of the unit should not exceed the rated value under any circumstance.

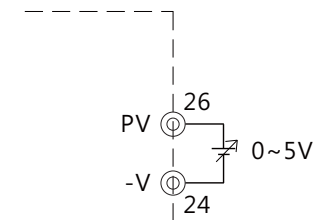
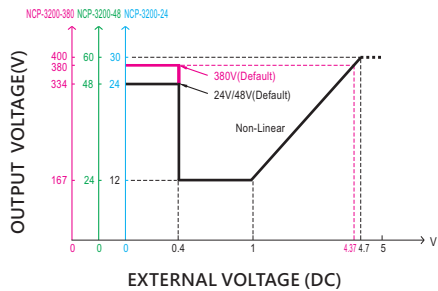
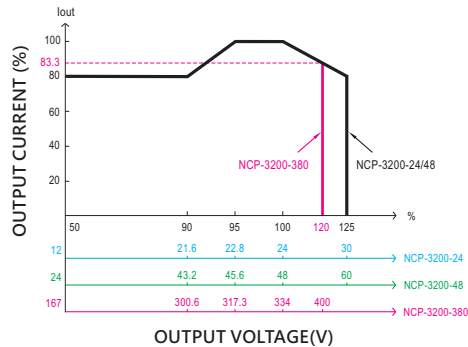

Figure 5-1



- © For power supply mode
- © The 100% output voltage is 24/48/334V



- © The rated current should change with the Output Voltage Programming accordingly
- © The 100% output current is 133/67/9.6A(NCP-3200) 532/268/38.4A(DHP-1UT-B(HV))
- © For Remote Sense / Local Sense, please refer to "Voltage Drop Compensation" section

Figure 5-2

### 5.5.3 Communication

Output voltage can be adjusted through communication interfaces: PMBus or CANBus. Please refer to chapter 6 for detailed information.

## 5.6 Output Current Adjustment

- Output current can be adjusted via PC and communication interface.

### 5.6.1 PC(Output Current Programming)

Output current of NCP-3200 in a DHP-1UT-B(HV) can be adjusted at the same time via a 0-5V DC source. Adjustable current range is 20 - 100% of the rated.

1. Connect output of the external DC source to PC(25) and -V(24) on CN1, as shown in Figure 5-3.
2. Relationship between output current and external DC source is shown in Figure 5-4.

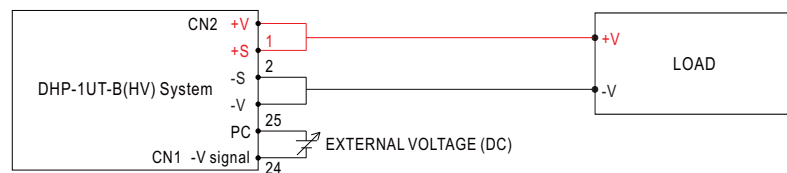

+S & +V, -S & -V also need to be connected on CN2.  
(Voltage compensation function for 24V/48V models under power supply system only)

Figure 5-3

### NCP-3200

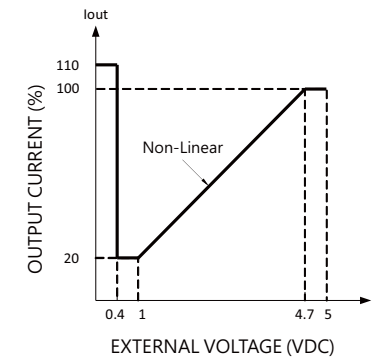

- © The 100% output current is 133/67/9.6A.
- © Notice the output power do not over max. output power.

### DHP-1UT-B(HV)

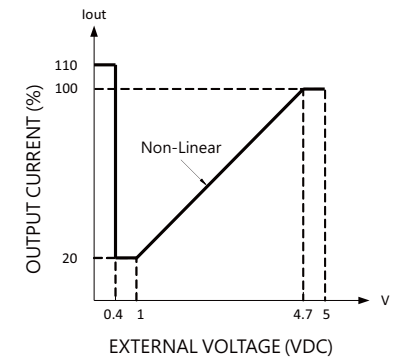

- © The 100% output current is 532/268/38.4A.
- © Notice the output power do not over max. output power.

Figure 5-4

Note: When the output current draw is at the constant current limited point for more than 5 seconds, the NCP-3200 will shut itself down for protection if it is set at the power supply mode.

### 5.6.2 Communication

Output current can be adjusted through communication interfaces: PMBus or CANBus. Please refer to chapter 6 for detail.

## 5.7 Fan Speed Control

- Built-in fan speed control circuit, fan speed changes depending on internal temperature.

## 5.8 AC-OK signal

- Built-in AC input voltage detection circuit.
- When AC input voltage  $\geq 87$  rms, the output voltage can start working normally and there will be a "High" signal (3.5 -5.5V) sent out through AC-OK on CN1. (Referenced to GND-AUX)
- When AC input voltage  $\leq 75$  rms, The output voltage shuts off and the red LED on the front panel will light up. In the meantime, there will be a "Low" signal (-0.5 -0.5V) sent out through AC-OK on CN1. (Referenced to GND-AUX)
- Maximum output current 10mA.

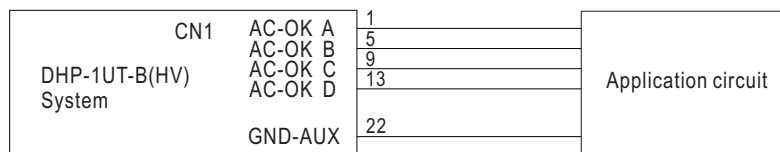

Figure 5-5

AC-OK signal	Input voltage range
"High" > 3.5~5.5V	Input voltage $\geq 87$ Vrms
"Low" < -0.5~0.5V	Input voltage $\leq 75$ Vrms

## 5.9 DC-OK signal

- Built-in DC output voltage detection circuit.
- When DC output voltage is within a normal value, there is a "Low" (-0.5-0.5V) signal sent out through DC-OK on CN1. (Referenced to GND-AUX).
- When DC output voltage is out of normal range, there is a "High" (3.5-5.5V) signal sent out through DC-OK on CN1. (Referenced to GND-AUX).
- Maximum output current 10mA.

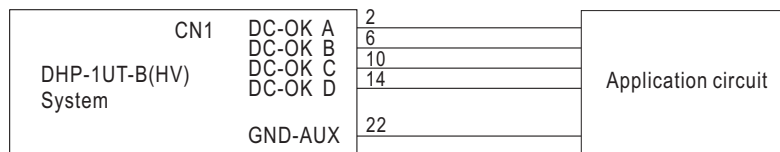

Figure 5-6

DC-OK signal	Power supply mode	Charger mode
"High" > 3.5~5.5V	Output voltage $\leq 77\% \pm 5\%$	Output voltage $\leq 66\% \pm 5\%$
"Low" < -0.5~0.5V	Output voltage $\geq 80\% \pm 5\%$	Output voltage $\geq 67\% \pm 5\%$

## 5.10 Remote Control

- Built-in remote control circuit, refer to Figure 5-7 for control methods of single unit or whole rack shelf.
- Please be aware that "ON/OFF" and "+5V-AUX" on CN1 should be linked together to allow the units operate normally; If kept open, there will be no output voltage.
- Maximum input voltage 5.5V.

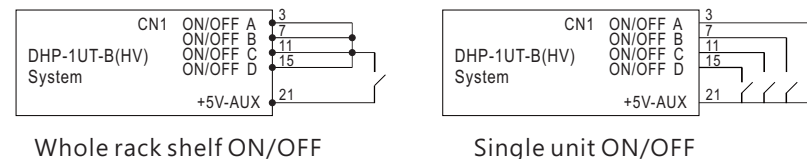

Figure 5-7

ON/OFF to +5V-AUX	Output
SW Open	OFF
SW Short	ON

## 5.11 Remote Sense (only for 24V/48V models in power supply mode)

- Built-in remote sense circuit that is able to compensate voltage drop up to 0.5V.
- When using this function, the sensing wires should either be twisted or shielded to prevent external noise interference (refer to Figure 5-8)
- Voltage drop across the output wires must be limited to less than 0.5V. Also wires with adequate current rating should be used between +V,-V and the loads. Please firmly connect the output wires to prevent them from loosening, or the power supply may be out of order.
- For Local Sense, the +S and -S have to be connected to the +V(signal) and -V(signal), respectively, as shown in Figure 5-9, in order to get the correct output voltage if Remote Sense is not used. Otherwise, the output voltage will increase to an extremely high level which may trigger OVP.

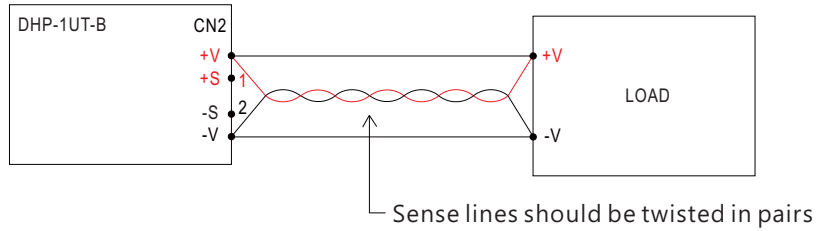

Figure 5-8 Connection of Remote Sense

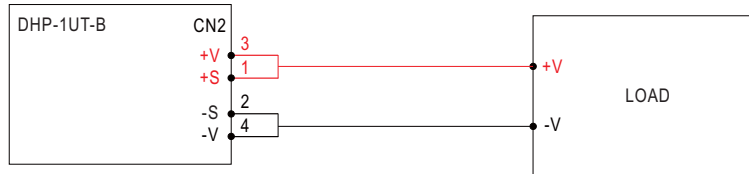

Figure 5-9 Connection of Local Sense

## 5.12 Parallel Operation

- Parallel operation is only suitable for the identical units (with the same model and the same output voltage/current). Up to 10 rack shelves and the maximum supply units that can be connected in parallel is 40.
- Because of component tolerance, there is a possibility that some of the units connected in parallel will reach an overcurrent limiting then overloading the other units when operating at full load condition. It is suggested that reduce the total output current by 10%. For example: NCP-3200-24x8 connected in parallel (in 2 rack shelves), the total output current should be reduced to  $133A \times 8\text{unit} \times 0.9 = 957.6A$ .
- Difference of output voltage among parallel units should be less than 0.2V.
- Configure rack shelf units in parallel before connecting to the load. Do not connect rack shelf units to the load separately. Refer to Figure 5-10.
- Control singles of DA, DB and -V should also be connected in parallel. (Refer to Figure 5-10).
- Use twisted wires for the wiring of +S and -S, the twisted wires should not touch the load wires to avoid interference. Refer to Figure 5-10.
- A too long cable length might be with a higher amount of noise that affects rack units' proper operation in parallel. To reduce the noise, installing termination resistors, an accessory, to the unused JK1 is recommended. Please refer to Accessory list.

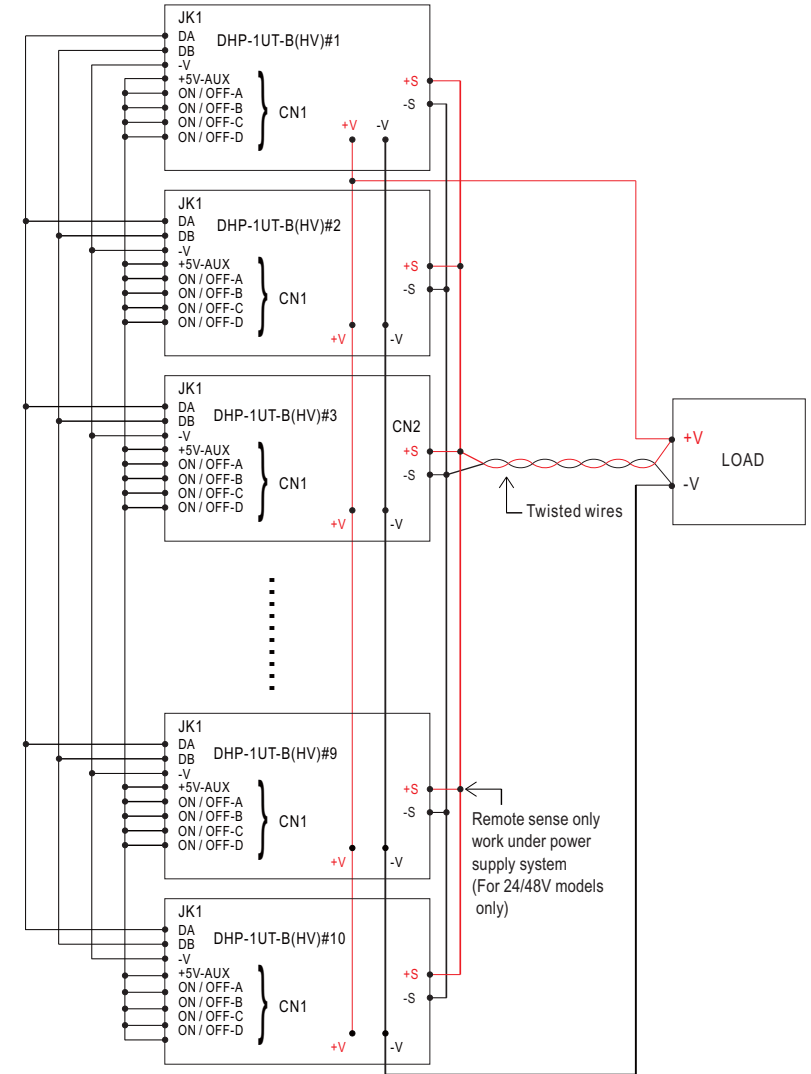

Figure 5-10

- ⊙ Under operation of more than one rack shelf in parallel, value of Ripple & Noise may be larger than that stated in the specification at light load or no load condition. It will return to normal level once the loads draw more current than 10% of the total rating.

### 5.13 Series Operation

- Higher output voltage can be acquired by connecting rack shelves in series.
- The rack shelves connected in series should have the identical rack supplies. Please refer to Figure 5-11 for wiring configuration.
- Total output current should not exceed currents that can be produced in each rack shelf.
- Difference of rise time in each unit may lead to steps/stairs during turn on.
- It is suggested that add external diodes (\*) on the output, shown in Figure 5-11, to prevent reverse voltage. Rating of these diodes should be higher than the total amount of output voltage and current.

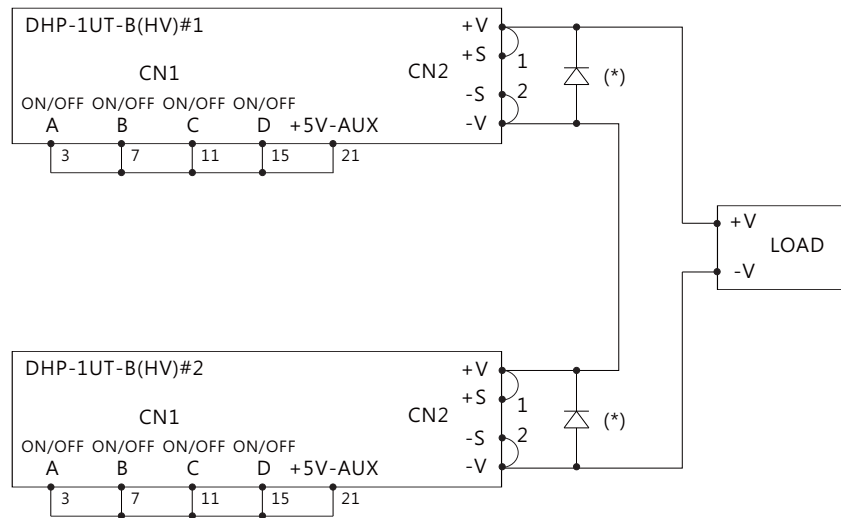

Figure 5-11 Configuration of rack shelf units in series

### 5.14 Auxiliary Output

- Built-in 12V/0.5A and 5V/0.3A auxiliary outputs.

+12V-AUX to GND-AUX	12Vdc/0.8A
+5V-AUX to GND-AUX	5Vdc/0.3A

### 5.15 Charge Function (24V/48V only)

- NCP-3200-24/48 adopt both 2 and 3 stage charging curves for selection. 2 stage is for easy and fast charging. 3 stage will go into float mode after the battery is fully charged. Users can choose between 2 or 3 stage according to the demand.
- Difference between power supply and charger modes is shown in the table below.

	Charger Mode	Power Supply Mode (Default)
Charging or PV/PC Control	Charging process is controlled automatically by the charger with preinstalled charging profile	Constant voltage output by default. Output voltage and current can be dynamically controlled via PV/PC or communication protocols
Battery Under-voltage or Overload Protection	$I_o > I_{set} * 95\%$ & $V_o < V_{boost} * 66\%$	$I_o > I_{set} * 95\%$ & $V_o < V_{set} * 77\%$
Applicable Commands	ON/OFF control, CURVE_CONFIG, monitoring command set	ON/OFF control, VOUT/IOUT_SET, monitoring command set NOTE: Communication mode needs to be enabled
Mode Selection	Set CURVE_CONFIG Bit 7 to 1 via communication protocols or use SBP-001 simply	Set CURVE_CONFIG Bit 7 to 0 via communication protocols or use SBP-001 simply

### 5.15.1.2 Stage Charging

In the initial stage of charging, the charger charges the battery with the maximum current. After a period of time (depending on the battery capacity), the charging current decreases gradually. When the charging current drops to 10% of the rated current and then LED indicator lights up in green, indicating that the charging process is complete.

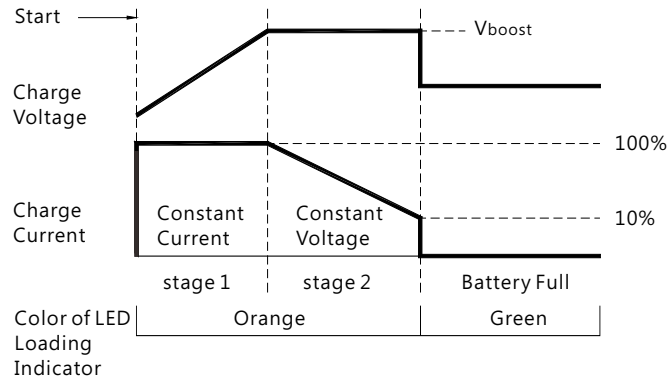

State	NCP-3200-24	NCP-3200-48
Constant Current	110A	55A
V <sub>boost</sub>	28.8V	57.6V

#### Explanation of 2 stage charging curve

- ① Initial stage (battery analysis) :  
Charger will detect and determine whether the battery is properly connected or it is already fully charged.
  - ② Stage 1 (Constant current) :  
Maximum constant current is applied for fast charging, until the voltage of battery reaches to boost voltage.
  - ③ Stage 2 (Constant voltage) :  
In this stage, charger applies a constant voltage on the battery. Charging current decreases gradually and then shuts down when charging current drops to 10% of rated current.
- \* Suitable for lead-acid batteries, such as flooded water type, Gel colloid type, AGM adsorption glass fiber, and lithium batteries, such as lithium-iron, lithium-manganese, ternary lithium.

### ◎ Embedded 2 stage charging curves

Model	Description	CC(default)	V <sub>boost</sub>
24V	Default, programmable	110A	28.8
	Pre-defined, gel battery		28
	Pre-defined, flooded		28.4
	Pre-defined, AGM battery		29
48V	Default, programmable	55A	57.6
	Pre-defined, gel battery		56
	Pre-defined, flooded		56.8
	Pre-defined, AGM battery		58

### 5.15.2.3 Stage Charging (default)

In the initial stage of charging, the charger charges the battery with the maximum current. After a period of time (depending on the battery capacity), the charging current decreases gradually. When the charging current drops to 10% of the rated current, LED indicator lights up in green, indicating that the charging process is completed and the charger remains at float charging stage.

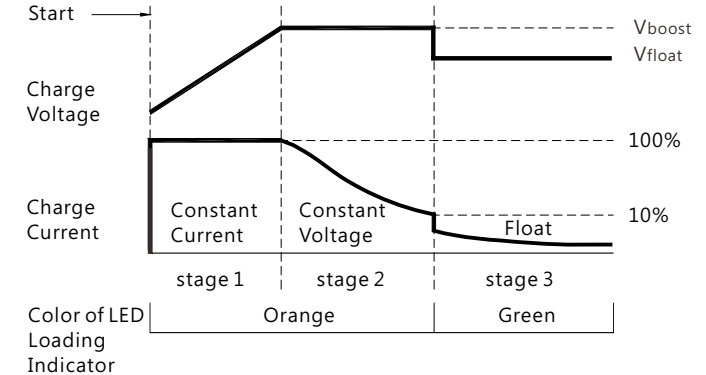

State	NCP-3200-24	NCP-3200-48
Constant Current	110A	55A
V <sub>boost</sub>	28.8V	57.6V
V <sub>float</sub>	27.6V	55.2V

© Embedded 3 stage charging curves

Model	Description	CC(default)	Vboost	Vfloat
24V	Default, programmable	110A	28.8	27.6
	Pre-defined, gel battery		28	27.2
	Pre-defined, flooded		28.4	26.8
	Pre-defined, AGM battery		29	27
48V	Default, programmable	55A	57.6	55.2
	Pre-defined, gel battery		56	54.4
	Pre-defined, flooded		56.8	53.6
	Pre-defined, AGM battery		58	54

**Explanation of 3 stage charging curve**

- ① Initial stage (battery analysis) :  
Charger will detect and determine whether the battery is properly connected or it is already fully charged.
  - ② Stage 1 (Constant current) :  
Maximum constant current is applied for fast charging, until the voltage of battery reaches to boost voltage.
  - ③ Stage 2 (Constant voltage) :  
In this stage, charger applies a constant voltage on the battery. Charging current decreases gradually and then goes into the final stage when charging current drops to 10% of rated current.
  - ④ Stage 3 (float charging) :  
The charger is able to provide a float voltage after 2 stage charging in order to keep the battery fully charged at all times. Especially suitable for lead-acid batteries.
- \* Suitable for lead-acid batteries, such as flooded water type, Gel colloid type, AGM adsorption glass fiber, and lithium batteries, such as lithium-iron, lithium-manganese, ternary lithium.

5.1.5.3 Charge mode setting – via communication interfaces

Users can set the unit at power supply mode or charger mode directly through command: CURVE\_CONFIG ( PMBus: 0xB4h; CANBus: 0x00B4)). Command: CURVE\_CONFIG also can be used to set the unit at 2 stage or 3 stage charge process and relevant charge settings. Please refer to chapter 6 Communication Protocol for detailed information.

5.1.5.4 Charge Mode Setting – via SBP-001

SBP-001, the smart battery charging programmer developed by MEAN WELL, can be used to set charging curves of the unit through editing the software. SBP-001 provides functions such as charging curve adjustment. Install configuration and software interface are shown as below. Please refer to "SBP-001 Smart Battery Charging Programmer User Manual" for details.

<http://www.meanwell.com.tw/webapp/product/search.aspx?prod=SBP-001&pdf=U0JQLUMucGRm&a=4>

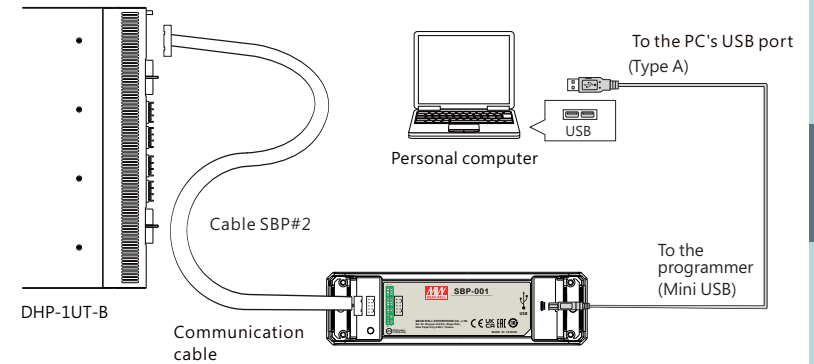

User Interface :

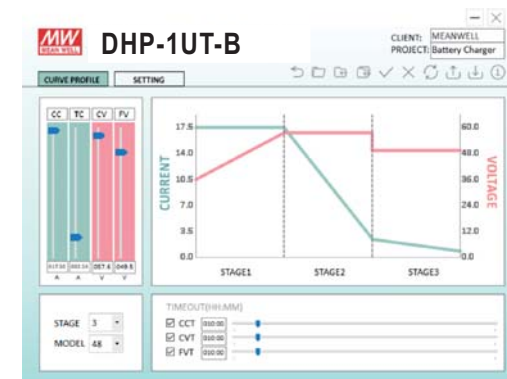

## 5.16 Factory Resetting

- Users can follow the steps below to restore factory settings for
  - PMBus: commands 01h, 22h, 46h, BEh and B0h ~ B7h ;
  - CANBus: commands 0x0000, 0x0020, 0x0030, 0x00C2 and 0x00B0~0x00B7
- Single unit: NCP-3200
  - ① Connect CN1's PIN 18/19/20/21 to CN1's PIN26.
  - ② Power on in REMOTE OFF mode (no output at this step)
  - ③ Within 15 seconds, connect CN1's PIN 18/19/20/21 to CN1's PIN26 → disconnect CN1's PIN 18/19/20/21 from CN1's PIN26 → connect CN1's PIN 18/19/20/21 to CN1's PIN26 again
  - ④ Green LED will flash 3 times if set successfully.
  - ⑤ If the EEPROM storage function was DISABLE (high byte bit 2 set to "logic 1" in SYSTEM\_CONFIG(0x00C2)), please perform step ① - ④ again to fully restore the parameters back to factory settings.
- Whole rack shelf: DHP-1UT-B(HV)
  - ① Turn off AC power and set positions of the SWA DIP switches to ON/ON/ON/ON.
  - ② Apply AC power with the rack unit in REMOTE OFF mode (there should be no output at this step).
  - ③ Within 15 seconds after AC power is applied, toggle all DIP switches from ON/ON/ON/ON to OFF/OFF/OFF/OFF and then back to ON/ON/ON/ON.
  - ④ Green LED will flash 3 times if set successfully.
  - ⑤ If the EEPROM storage function was DISABLE (high byte bit 2 set to "logic 1" in SYSTEM\_CONFIG(0x00C2)), please perform step ① - ④ again to fully restore the parameters back to factory settings.

## 6. Communication Protocol

- There are two means to control the unit, analog signals and digital communication. Analog is the default setting for the unit, signals including PV, PC and SVR can be used immediately once receiving the unit. The digital communication (PMBus or CANBus) is initially uncontrollable but readable. To activate the adjustment commands of OPERATRION, VOUT\_TRIM/VOUT\_SET or IOUT\_OC\_FAULT\_LIMIT/IOUT\_SET., ect., set PM\_CTRL/CAN\_CTRL of SYSTEM\_CONFIG (PMBus: BEh; CANBus: 0x00C2) at "1" and then reboot the unit. Once the digital communication dominates the unit, the analog signals become invalid.
- When it is opted for charging curve, CURVE\_CONFIG (PM: B4h; CAN: 0x00B4): Low byte Bit 7 = 1, charging curve function is enabled with additional PMBus or CANBus commands. There are 4 built-in charging curves, default curve, one predefined curve for gel battery, one predefined curve for flooded battery and one predefined curve for AGM battery. Each curve can be selected by Command CURVE\_CONFIG (PM: B4h; CAN: 0x00B4). In addition, users are able to customize their own charge curves through the commands below, which will be stored to the default curve after modification.

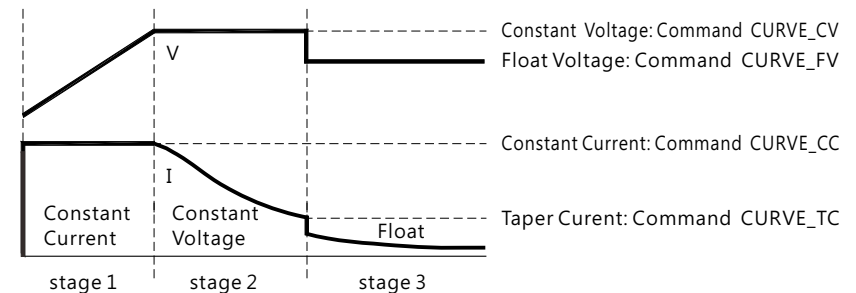

### NOTE:

1. Remote OFF/ON or OPERATION OFF/ON, as well as AC recycling, can be used to activate new curve procedures and import parameters and settings for a new curve profile. Additionally, they can also release protections caused by CURVE\_CC\_TIMEOUT, CURVE\_CV\_TIMEOUT, or CURVE\_TP\_TIMEOUT due to timeouts.

2. When EEP\_OFF of SYSTEM\_CONFIG (PM: BEh; CAN: 0x00C2) is set to logic 1 (parameters NOT to be saved into EEPROM), changes to charge curve parameters, such as CURVE\_CC, CURVE\_CV, CURVE\_FV, and CURVE\_TV, can still take effect after remote OFF/ON or OPERATION OFF/ON. However, the new setting values for a new curve profile will be lost if EEP\_OFF of SYSTEM\_CONFIG is at logic 1 and AC is recycled.
3. When charging curve is enabled, the following commands will be invalid while other commands are still effective: Command VOUT\_TRIM(22h)/VOUT\_SET(0x0020) (regarding Output voltage programming function) and Command IOUT\_OC\_FAULT\_LIMIT(46h)/IOUT\_SET(0x0030) (regarding Output current programming function).
4. Changing parameters to CUVE (Low byte: Bit 7) of CURVE\_CONFIG command requires a reboot to take effect.

## 6.1 PMBus Communication Interface

- NCP-3200 is compliant with PMBus Rev.1.1, the maximum communication speed is 100KHz and has the capability of identifying up to 64 addressed units.
- PMBus communication interface is able to provide the current operating status and information. Supported information is as below:
  1. Output voltage, current and internal temperature
  2. Alarm and status.
  3. Manufacturer and mode data.
  4. Enabling/disabling of charger mode and Read/wire on charge curve settings.

### 6.1.1 PMBus Device Addressing

Each NCP-3200 unit should have their unique and own device address to communicate over the PMBus. 7-bit address setting is used to assign advice address, shown in the description below.

MSB						LSB
1	A5	A4	A3	A2	A1	A0

Please refer to 4.4 Communication Address/ID Assignment for detailed information on address assignment.

### 6.1.2 PMBus Command List

© The command list of the NCP-3200 is shown in Table 6-1. It is compliant with the standard protocol of PMBus Rev. 1.1. For detailed information, please refer to PMBus official website (<http://pmbus.org/specs.html>).

Table 6-1

Command Code	Command Name	Transaction Type	# of data Bytes	Description
01h	OPERATION	R/W Byte	1	Remote ON/OFF control
02h	ON_OFF_CONFIG	Read Byte	1	ON/OFF function configuration
19h	CAPABILITY	Read Byte	1	Capabilities of a PMBus device
20h	VOUT_MODE	Read Byte	1	Define data format for output voltage 24/48V: format: Linear 16, N= -9 380V: format: Linear 16, N= -7
21h	VOUT_COMMAND	Read Word	2	Define data format for output voltage
22h	VOUT_TRIM*	R/W Word	2	Output voltage trimmed value
46h	IOUT_FAULT_LIMIT*	R/W Word	2	Output overcurrent setting value 24/48V: format: Linear 11, N= -2 380V: format: Linear 11, N= -6
47h	IOUT_OC_FAULT_RESPONSE	Read Byte	1	Define protection and response when an output overcurrent fault occurred
79h	STATUS_WORD	Read Word	2	Summary status reporting
7Ah	STATUS_VOUT	Read Byte	1	Output voltage status reporting
7Bh	STATUS_IOUT	Read Byte	1	Output current status reporting
7Ch	STATUS_INPUT	Read Byte	1	AC input voltage status reporting
7Dh	STATUS_TEMPERATURE	Read Byte	1	Temperature status reporting
7Eh	STATUS_CML	Read Byte	1	Communication, logic, Memory status reporting
80h	STATUS_MFR_SPECIFIC	Read Byte	1	Manufacture specific status reporting
81h	STATUS_FANS_1_2	Read Byte	1	Fan1 and 2 status reporting
88h	READ_VIN	Read Word	2	Input voltage reading value (format: Linear 11, N=-1)
8Bh	READ_VOUT	Read Word	2	Output voltage reading value 24/48V: format: Linear 16, N= -9 380V: format: Linear 16, N= -7
8Ch	READ_IOUT	Read Word	2	Output current reading value 24/48V: format: Linear 11, N= -2 380V: format: Linear 11, N= -6
8Dh	READ_TEMPERATURE_1	Read Word	2	Internal temperature reading value (format: Linear 11, N= -3)
90h	READ_FAN_SPEED_1	Read Word	2	Fan speed 1 reading value format: Linear 11, N= 5
91h	READ_FAN_SPEED_2	Read Word	2	Fan speed 2 reading value format: Linear 11, N= 5
98h	PMBUS_REVISION	Read Byte	1	The compliant revision of the PMBus
99h	MFR_ID	Block Read	12	Manufacturer's name
9Ah	MFR_MODEL	Block Read	12	Manufacturer's model name
9Bh	MFR_REVISION	Block Read	24	Firmware revision
9Ch	MFR_LOCATION	Block R/W	3	Manufacturer's factory location
9Dh	FR_DATE_B0B5	Block R/W	6	Manufacture date (format: YYMMDD)
9Eh	MFR_SERIAL	Block Read	12	Product serial number

Command Code	Command Name	Transaction Type	# of data Bytes	Description
B0h	CURVE_CC*	R/W Word	2	Constant current setting of charge curve 24/48V: format: Linear, 11= -2 380V: no support
B1h	CURVE_CV*	R/W Word	2	Constant voltage setting of charge curve 24/48V: format: Linear, 16= -9 380V: no support
B2h	CURVE_FV*	R/W Word	2	Floating voltage setting of charge curve 24/48V: format: Linear, 16= -9 380V: no support
B3h	CURVE_TC*	R/W Word	2	Taper current setting of charge curve 24/48V: format: Linear, 11= -2 380V: no support
B4h	CURVE_CONFIG	R/W Word	2	Configuration setting of charging curve 380V: no support
B5h	CURVE_CC_TIMEOUT	R/W Word	2	CC stage timeout setting value of charging curve 380V: no support
B6h	CURVE_CV_TIMEOUT	R/W Word	2	CV stage timeout setting value of charging curve 380V: no support
B7h	CURVE_FLOAT_TIMEOUT	R/W Word	2	Floating timeout setting value of charging curve 380V: no support
B8h	CHG_STATUS	READ Word	2	Charger's status reporting 380V: no support
BEh	SYSTEM_CONFIG	R/W Word	2	System status
BFh	SYSTEM_STATUS	READ Word	2	System status

Note: Setting commands with \* at the end support the EEP\_OFF function.

For detailed information on how to enable them, please refer to SYSTEM\_CONFIG (BEh).

### Definition of Command B4h CURVE\_CONFIG :

	Bit7	Bit6	Bit5	Bit4	Bit3	Bit2	Bit1	Bit0
High byte	-	-	-	-	-	FVTOE	CVTOE	CCTOE
Low byte	CUVE	STGS	-	-	-	-	-	CUVS

Low byte

Bit 0:1 CUVS : Charge Curve Selection

00 = Customized Charge Curve (default)

01 = Gel Battery

10 = Flooded Battery

11 = AGM Battery

Bit 6 STGS : 2/3 Stage Charge Setting

0 = 3 stage charge (default, CURVE\_VBST and CURVE\_V FLOAT)

1 = 2 stage charge (only CURVE\_VBST)

Bit 7 CUVE : Charge Curve Function Enable

0 = disabled, power supply mode(default)

1 = enabled, charger mode

High byte

Bit 0 CCTOE : Constant Current Stage Timeout Indication Enable

0 = disabled (default)

1 = enabled

Bit 1 CVTOE : Constant Voltage Stage Timeout Indication Enable

0 = disabled (default)

1 = enabled

Bit 2 FVTOE : Float Voltage Stage Timeout Indication Enable

0 = disabled (default)

1 = enabled

© Definition of Command B8h CHG\_STATUS :

	Bit7	Bit6	Bit5	Bit4	Bit3	Bit2	Bit1	Bit0
High byte	FVTOF	CVTOF	CCTOF	-	BTNC	-	-	-
Low byte	-	-	-	-	FVM	CVM	CCM	FULLM

Low byte

Bit 0 FULLM : Fully Charged Mode Status

0 = NOT fully charged

1 = fully charged

Bit 1 CCM : Constant Current Mode Status

0 = the charger NOT in constant current mode

1 = the charger in constant current mode

Bit 2 CVM : Constant Voltage Mode Status

0 = the charger NOT in constant voltage mode

1 = the charger in constant voltage mode

Bit 3 FVM : Float Mode Status

0 = the charger NOT in float mode

1 = the charger in float mode

High byte

Bit 3 BTNC : Battery Detection

0 = battery detected

1 = No battery detected

Bit 5 CCTOF : Time Out Flag of Constant Current Mode

0 = NO time out in constant current mode

1 = constant current mode timed out

Bit 6 CVTOF : Time Out Flag of Constant Voltage Mode

0 = NO time out in constant voltage mode

1 = constant voltage mode timed out

Bit 7 FVTOF : Time Out Flag of Float Voltage Mode

0 = NO time out in float mode

1 = float mode timed out

Note :

BTNC : When there is no battery detected, the charger stops charging the battery and the LED indicator turns red. The charger needs to re-power on to re-start charging the battery.

CCTOF : When timeout arises in the Constant Current stage, the charger stops charging the battery and the LED indicator turns red. The charger needs to re-power on or remote on/off to re-start charging the battery.

CVTOF : When timeout arises in the Constant Voltage stage, the charger stops charging the battery and the LED indicator turns red. The charger needs to re-power on or remote on/off to re-start charging the battery.

FVTOF : When timeout arises in the Float stage, the charger stops charging the battery and the LED indicator turns green. This charging flow is finished; the charger needs to re-power on or remote on/off to start charging a different battery.

© Definition of Command BEh SYSTEM\_CONFIG :

	Bit7	Bit6	Bit5	Bit4	Bit3	Bit2	Bit1	Bit0
High byte	-	-	-	-	-	EEP_OFF	-	-
Low byte	-	-	-	-	-	OPERATION_INIT	PM_CTRL	

Low byte

Bit 0 PM\_CTRL: PMBus Control Selection

0 = Output voltage and current controlled by SVR/PV/PC (default)

1 = Output voltage, current and remote ON/OFF controlled by PMBus (VOUT\_TRIM \ IOUT\_FAULT\_LIMIT \ OPERATION)

Bit 1: 2 OPERATION\_INIT: OPERATION\_INIT : Initial Operational Behavior

0b00 = power on with 0x00: OFF

0b01 = power on with 0x80: ON(default)

0b10 = power on with the last setting

0b11 = Not used

High byte

Bit 2 EEP\_OFF: EEPROM storage function ON/OFF

0: Enable. Parameters to be saved into EEPROM

1: Disable. Parameters NOT to be saved into EEPROM

Note: Unsupported settings display with "0"

© Definition of Command BFh SYSTEM\_STATUS :

	Bit7	Bit6	Bit5	Bit4	Bit3	Bit2	Bit1	Bit0
High byte	-	-	-	-	-	-	-	-
Low byte	-	EEPER	INITIAL_STATE	ADL_ON	-	PFC_OK	DC_OK	M/S

Low byte

Bit 0: M/S : Parallel mode status

0 = Current device is Slave

1 = Current device is Master

Bit 1: DC\_OK : Secondary DD output voltage status  
 0 = Secondary DD output voltage status TOO LOW  
 1 = Secondary DD output voltage status NORMAL

Bit 2: PFC\_OK : Primary PFC status  
 0 = Primary PFC OFF or abnormal  
 1 = Primary PFC ON normally

Bit 4 ADL\_ON : Active dummy load control status  
 0 = Active dummy load off  
 1 = Active dummy load on

Bit 5 INITIAL\_STATE : Device initialized status  
 0 = NOT in initialization status  
 1 = In initialization status

Bit 6 EEPER: EEPROM data access error  
 0 = EEPROM data access normal  
 1 = EEPROM data access error

Note:

1. When an EEPROM data access error occurs, the supply shuts itself down and then entering a protection mode with the LED indicator in red. It only can be recovered after the EEPROM error condition is resolved.
2. Unsupported settings display with "0"

### 6.1.3 Notes on PMBus

1. Insert a at least 50msec delay between commands
2. Examples for Format Conversion :

(1) LINEAR16 format : VOUT\_COMMAND 、 VOUT\_TRIM 、 READ\_VOUT 、 CURVE\_CV 、 CURVE\_FV ◦

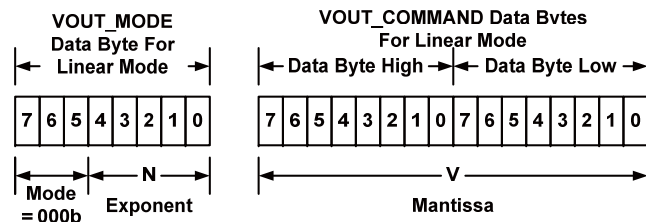

Linear Format Data Bytes

The Mode bits are set to 000b.

The Voltage, in volts, is calculated from the equation:

$$\text{Voltage} = V \cdot 2^N$$

Where:

Voltage is the parameter of interest in volts;

V is a 16 bit unsigned binary integer; and

N is a 5 bit two's complement binary integer.

EX:  $V_{o\_real}$  (actual output voltage) =  $V \times 2^N$ , V is from READ\_VOUT.

If VOUT\_MODE = 0x17, meaning N is -9. READ\_VOUT is 0x3000 → 12288, then  $V_{o\_real} = 12288 \times 2^{-9} = 24.0V$ .

(2) LINEAR11 format : IOUT\_OC\_FAULT\_LIMIT 、 READ\_VIN 、 READ\_IIN 、 READ\_IOUT 、 READ\_TEMPERATURE\_1 、 READ\_FAN\_SPEED\_1 、 READ\_FAN\_SPEED\_2 、 CURVE\_CC 、 CURVE\_TC 、 CURVE\_CC\_TIMEOUT 、 CURVE\_CV\_TIMEOUT 、 CURVE\_FV\_TIMEOUT ◦

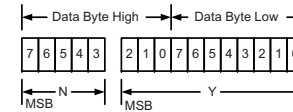

Linear Data Format Data Bytes Y, N and the "real world" value is:

The relation between

$$X = Y \cdot 2^N$$

Where, as described above:

X is the "real world" value;

Y is an 11 bit, two's complement integer; and

N is a 5 bit, two's complement integer.

Devices that use the Linear format must accept and be able to process any value of N.

EX:  $I_{o\_real}$  (actual output current) =  $Y \times 2^N$ , Y is from READ\_IOUT.

If READ\_IOUT is 0xF188, meaning N is -2 and Y is 0x0188. Y is 0x0188 → 392, then  $I_{o\_real} = 392 \times 2^{-2} = 98.0A$ .

### 6.1.4 Communication example - practical operation of charger mode

The following steps will describe how to set the NCP-3200-48 to charger mode and adjust its curve for a 2-stage charging process, with a constant current (CC) of 50A and a constant voltage (CV) of 56V.

1. Set the address of the rack supply to "0", by installing the rack supply in the far right slot or Module A and then setting the SWA DIP switch to ON/ON/ON/ON positions.

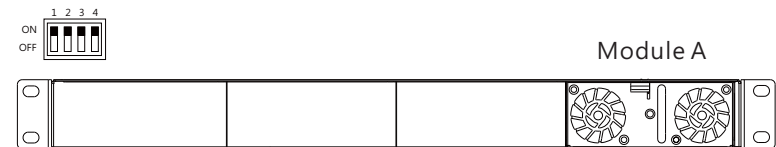

DHP-1UT-B

2. Connect the SDA, SCL, and GND pins of the master to the corresponding SDA (PIN6), SCL (PIN7), and GND-AUX (PIN8) pins of the JK1 connector on the rack shelf.

©Set speed: 100KHz

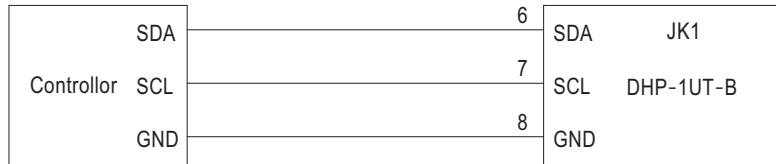

3. Configure communication settings after power on in remote off mode. Enable its charging functionality by setting the rack supply to charger mode and 2-stage charging mode.

Address(7 bit)	Operation	Command Code	Data
0x40	Write	0xB4	0xC0, 0x00

Command code: 0xB4(CURVE\_CONFIG)

Data: C0(Lo) + 00(Hi). Please refer to definition of CURVE\_CONFIG for detailed information

4. Set the constant current (CC) point to 50A

Address(7 bit)	Operation	Command Code	Data
0x40	Write	0xB0	0xC8, 0xF0

Command code: 0xB0(CURVE\_CC)

Data: 50A → 0xC8(Lo) + 0xF0(Hi)

CURVE\_CC is LINEAR11 format

5. Set the constant voltage (CV) point to 56V

Address(7 bit)	Operation	Command Code	Data
0x40	Write	0xB1	0x00, 0x70

Command code: 0xB1(CURVE\_CV)

Data: 56V → 0x00(Lo) + 0x70(Hi)

NOTE: CURVE\_CV is LINEAR16 format

6. Before connecting to the batteries, it is recommended to review all of the settings and parameters using the appropriate commands. In the event that they do not meet your requirements, you may rewrite them as needed.

EX: Read CURVE\_CV to check whether CV level or Vboost was set to a proper level.

Read CURVE\_CV

Address(7 bit)	Operation	Command Code
0x40	Read	0xB1

The unit returns data below

Address(7 bit)	Data
0x40	0x00, 0x70

Data: 0x00(Lo) + 0x70(Hi) → 0x7000 →  $28672 \times 2^{-9} = 56V$

7. Finally, short circuit ON-OFF (PIN3) and +5-AUX (PIN21) pins of the CN1 connector on the rack shelf to remote on the supply to charge the batteries.

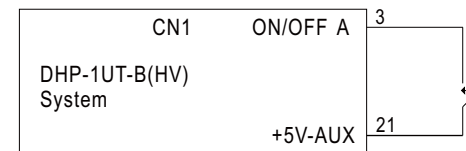

## 6.2 CANBus Communication Interface

- Physical layer specification  
This protocol follows CAN ISO-11898 with Baud rate of 250Kbps.
- Data Frame  
This protocol uses Extended CAN 29-bit identifier frame format or CAN 2.0B.

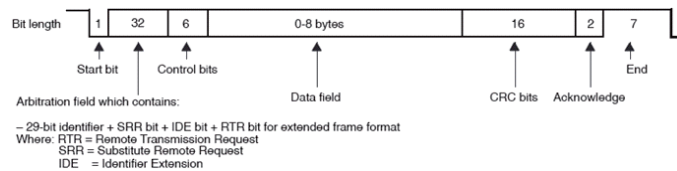

- Communication Timing  
Min. request period (Controller to NCP-3200): 50mSec ◦  
Max. response time (NCP-3200 to Controller): 12.5mSec ◦  
Min. packet margin time (Controller to NCP-3200): 12.5mSec ◦

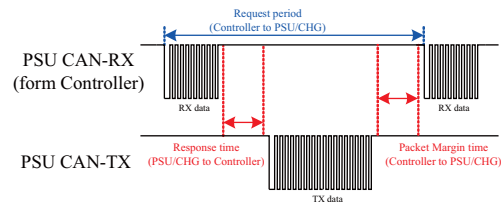

- Data Field Format  
Controller to NCP-3200  
Write: please refer to section 6.2.3.1 for an actual  
Data field bytes

0	1	2	3
COMD. low byte	COMD. high byte	Data low byte	Data high byte

- Read: please refer to section 6.2.3.2 for an actual example  
Data field bytes

0	1
COMD. low byte	COMD. high byte

- NCP-3200 to Controller  
Response: please refer to section 6.2.3.3 for an actual example  
Data field bytes

0	1	2	.....	7
COMD. low byte	COMD. high byte	Data low 1		Data high 6

NOTE: NCP-3200 will not send data back when writing parameters, such as VOUT\_SET

### 6.2.1 Message ID definition

Message ID	Description
0x000C00XX	NCP-3200 to Controller Message ID
0x000C01XX	Controller to NCP-3200 Message ID
0x000C01FF	Controller broadcasts to NCP-3200

XX means the CAN ID of NCP-3200. Please refer to 4.4 Communication Address/ID Assignment for detailed information on ID assignment.

### 6.2.2 CANBus Command list

The CANBus command list of the NCP-3200 is shown in the table 6-2 below.

Command Code	Command Name	Transaction Type	# of data Bytes	Description
0x0000	OPERATION	R/W	1	ON/OFF control ON: 01h OFF: 00h
0x0020	VOUT_SET*	R/W	2	Output voltage set (format: value, F=0.1)
0x0030	IOUT_SET*	R/W	2	Output current set (format: value, F=0.1)
0x0040	FAULT_STATUS	R	2	Abnormal status
0x0050	READ_VIN	R	2	Input voltage read value (format: value, F=0.1)
0x0060	READ_VOUT	R	2	Output voltage read value (format: value, F=0.1)
0x0061	READ_IOUT	R	2	Output current read value (format: value, F=0.1)
0x0062	READ_TEMPERATURE_1	R	2	Internal ambient temperature (format: value, F=0.1)
0x0070	READ_FAN_SPEED_1	R	2	Fan speed 1 reading value (format: value, F=1)
0x0071	READ_FAN_SPEED_2	R	2	Fan speed 2 reading value (format: value, F=1)
0x0080	MFR_ID_B0B5	R	6	Manufacture's name
0x0081	MFR_ID_B6B11	R	6	Manufacture's name
0x0082	MFR_MODEL_B0B5	R	6	Manufacture model name
0x0083	MFR_MODEL_B6B11	R	6	Manufacture model name
0x0084	MFR_REVISION_B0B5	R	6	Firmware version
0x0085	MFR_LOCATION_B0B2	R/W	3	Manufacture place
0x0086	MFR_DATE_B0B5	R/W	6	Manufacture date

Command Code	Command Name	Transaction Type	# of data Bytes	Description
0x0087	MFR_SERIAL_B0B5	R/W	6	Manufacture serial number
0x0088	MFR_SERIAL_B6B11	R/W	6	Manufacture serial number
0x00B0	CURVE_CC* (380V model not supported)	R/W	2	Constant current setting of charge curve (format: value, F=0.1)
0x00B1	CURVE_CV* (380V model not supported)	R/W	2	Constant voltage setting of charge curve (format: value, F=0.1)
0x00B2	CURVE_FV* (380V model not supported)	R/W	2	Floating voltage setting of charge curve (format: value, F=0.1)
0x00B3	CURVE_TC* (380V model not supported)	R/W	2	Taper current setting of charge curve (format: value, F=0.1)
0x00B4	CURVE_CONFIG (380V model not supported)	R/W	2	Configuration setting of charge curve
0x00B5	CURVE_CC_TIMEOUT (380V model not supported)	R/W	2	CC charge timeout setting of charging curve (format: value, F=1)
0x00B6	CURVE_CV_TIMEOUT (380V model not supported)	R/W	2	CV charge timeout setting of charging curve (format: value, F=1)
0x00B7	CURVE_FV_TIMEOUT (380V model not supported)	R/W	2	FV charge timeout setting of charging curve (format: value, F=1)
0x00B8	CHG_STATUS (380V model not supported)	R	2	Charging status reporting
0x00C0	SCALING_FACTOR	R	6	Scaling ratio
0x00C1	SYSTEM_STATUS	R	2	System status
0x00C2	SYSTEM_CONFIG	R/W	2	System configuration

Note: Setting commands with \* at the end support the EEP\_OFF function.  
For detailed information on how to enable them, please refer to SYSTEM\_CONFIG (0x00C2).

#### Data conversion :

The conversion of setting and reading values is defined as following:  
Actual value = Communication reading value × Factor (F value). Among them, Factor needs to refer to the definition of SCALING\_FACTOR in each model list.

EX:  $V_{o\_real}$  (actual DC voltage) =  $READ\_VOUT \times Factor$ .

If the Factory of  $READ\_VOUT$  of a certain mode is 0.1, the communication reading value is 0x00F0 (hexadecimal) → 240(decimal), then  $VDC\_real = 240 \times 0.1 = 24.0V$ .

#### ◎Definition of FAULT\_STATUS (0x0040) :

	Bit7	Bit6	Bit5	Bit4	Bit3	Bit2	Bit1	Bit0
High byte	-	-	-	-	-	-	-	-
Low byte	HI_TEMP	OP_OFF	AC_FAIL	SHORT	OLP	OVP	OTP	FAN_FAIL

Low byte

Bit 0 FAN\_FAIL : Fan locked flag

0 = Working normally

1 = Fan locked

Bit 1 OTP : Over temperature protection

0 = Internal temperature normal

1 = Internal temperature abnormal

Bit 2 OVP : DC over voltage protection

0 = DC voltage normal

1 = DC over voltage protected

Bit 3 OLP : DC over current protection

0 = DC current normal

1 = DC over current protected

Bit 4 SHORT : Short circuit protection

0 = Shorted circuit do not exist

1 = Shorted circuit protected

Bit 5 AC\_FAIL : AC abnormal flag

0 = AC input range normal

1 = AC input range abnormal

Bit 6 OP\_OFF : DC status

0 = DC output turned on

1 = DC output turned off

Bit 7 HI\_TEMP : Internal high temperature alarm

0 = Internal temperature normal

1 = Internal temperature abnormal

Note: Unsupported settings displays with "0"

©MFR\_ID\_B0B5 (0x0080) is the first 6 codes of the manufacturer's name (ASCII); MFR\_ID\_B6B11 (0x0081) is the last 6 codes of the manufacturer's name (ASCII)

EX: Manufacturer's name is MEANWELL MFR\_ID\_B0B5 is MEANWE ;  
MFR\_ID\_B6B11 is LL

MFR_ID_B0B5					
Byte 0	Byte 1	Byte 2	Byte 3	Byte 4	Byte 5
0x4D	0x45	0x41	0x4E	0x57	0x45

MFR_ID_B6B11					
Byte 0	Byte 1	Byte 2	Byte 3	Byte 4	Byte 5
0x4C	0x4C	0x20	0x20	0x20	0x20

©MFR\_MODEL\_B0B5 (0x0082) is the first 6 codes of the manufacturer's model name (ASCII); MFR\_MODEL\_B6B11 (0x0083) is the last 6 codes of the manufacturer's model name (ASCII)

EX: Model names is NCP-3200-48 → MFR\_MODEL\_B0B5 is NCP-32 ;  
MFR\_MODEL\_B6B11 is 00-48

MFR_MODEL_B0B5					
Byte 0	Byte 1	Byte 2	Byte 3	Byte 4	Byte 5
0x4E	0x43	0x50	0x2D	0x33	0x32

MFR_ID_B6B11					
Byte 6	Byte 7	Byte 8	Byte 9	Byte 10	Byte 11
0x30	0x30	0x2D	0x34	0x38	0x20

©MFR\_REVISION\_B0B5 (0x0084) is the firmware revision (hexadecimal). A range of 0x00 (R00.0)~0xFE (R25.4) represents the firmware version of an MCU; 0xFF represents no MCU existed.

EX: The supply has two MCUs, the firmware version of the MCU number 1 is version R25.4 (0xFE), the MCU number 2 is version R10.5 (0x69)

Byte 0	Byte 1	Byte 2	Byte 3	Byte 4	Byte 5
0xFE	0x69	0xFF	0xFF	0xFF	0xFF

©MFR\_DATE\_B0B5 (0x0086) is manufacture date (ASCII)

EX: MFR\_DATE\_B0B5 is 180101, meaning 2018/01/01

Byte 0	Byte 1	Byte 2	Byte 3	Byte 4	Byte 5
0x31	0x38	0x30	0x31	0x30	0x31

©MFR\_SERIAL\_B0B5 (0x0087) and MFR\_SERIAL\_B6B11 (0x0088) are defined as manufacture date and manufacture serial number (ASCII)

EX: The first unit manufactured on 2018/01/01→MFR\_SERIAL\_B0B5: 180101 ; MFR\_SERIAL\_B6B11: 000001

Byte 0	Byte 1	Byte 2	Byte 3	Byte 4	Byte 5
0x31	0x38	0x30	0x31	0x30	0x31

Byte 6	Byte 7	Byte 8	Byte 9	Byte 10	Byte 11
0x30	0x30	0x30	0x30	0x30	0x31

©CURVE\_CONFIG(0x00B4, only for charger) :

	Bit7	Bit6	Bit5	Bit4	Bit3	Bit2	Bit1	Bit0
High byte	-	-	-	-	-	FVTOE	CVTOE	CCTOE
Low byte	CUVE	STGS	-	-	-	-	CUVS	

Low byte

Bit 0:1 CUVS : Charge Curve Selection

00 = Customized charge Curve(default)

01 = Gel Battery

10 = Flooded Battery

11 = AGM Battery

Bit 6 STGS : 2/3 Stage Charge Setting

0 = 3 stage charge (default)

1 = 2 stage charge

Bit 7 CUVE : Charge Curve Function Enable

0 = disabled, power supply mode(default)

1 = enabled, charger mode

High byte:

Bit 0 CCTOE : Constant Current Stage Timeout Indication Enable

0= disable (default)

1= enabled

Bit 1 CVTOE : Constant Voltage Stage Timeout Indication Enable

0= disable (default)

1= enabled

Bit 2 FTTOE : Float Voltage Stage Timeout Indication Enable

0= disable (default)

1= enabled

Note: Unsupported settings displays with "0"

©CHG\_STATUS(0x00B8, only for charger) :

	Bit7	Bit6	Bit5	Bit4	Bit3	Bit2	Bit1	Bit0
High byte	FVTOF	CVTOF	CCTOF	-	BTNC	-	-	-
Low byte	-	-	-	-	FVM	CVM	CCM	FULLM

Low byte

Bit 0 FULLM : Fully Charged Mode Status

0= NOT fully charged

1= fully charged

Bit 1 CCM : Constant Current Mode Status

0= the charger NOT in constant current mode

1= the charger in constant current mode

Bit 2 CVM : Constant Voltage Mode Status

0= the charger NOT in constant voltage mode

1= the charger in constant voltage mode

Bit 3 FVM : Float Mode Status

0= the charger NOT in float mode

1= the charger in float mode

High byte:

Bit 3 BTNC : Battery Detection

0= battery detected

1= No battery detected

Bit 5 CCTOF : Time Out Flag of Constant Current Mode

0= NO time out in constant current mode

1= constant current mode timed out

Bit 6 CVTOF : Time Out Flag of Constant Voltage Mode

0= NO time out in constant voltage mode

1= constant voltage mode timed out

Bit 7 FTTOF : Time Out Flag of Float Mod

0= NO time out in float mode

1= float mode timed out

Note: Unsupported settings displays with "0"

©SCALING\_FACTOR(0x00C0) :

Bit7~Bit0								
byte4~5	Reserved							
	Bit7	Bit6	Bit5	Bit4	Bit3	Bit2	Bit1	Bit0
byte3	Reserved				Reserved			
	Bit7	Bit6	Bit5	Bit4	Bit3	Bit2	Bit1	Bit0
byte2	CURVE_TIMEOUT Factor				TEMPERATURE_1 Factor			
	Bit7	Bit6	Bit5	Bit4	Bit3	Bit2	Bit1	Bit0
byte1	FAN_SPEED Factor				VIN Factor			
	Bit7	Bit6	Bit5	Bit4	Bit3	Bit2	Bit1	Bit0
byte0	IOUT Factor				VOUT Factor			

byte0:

Bit 0:3 VOUT Factor : The factor of output voltage

0x0=Output voltage relevant commands not supported

0x4=0.001

0x5=0.01

0x6=0.1

0x7=1.0

0x8=10

0x9=100

Bit 4:7 IOUT Factor : The Factor of DC current  
 0x0=Output current relevant commands not supported  
 0x4=0.001  
 0x5=0.01  
 0x6=0.1  
 0x7=1.0  
 0x8=10  
 0x9=100

byte1:

Bit 0:3 VIN Factor : The Factor of AC input voltage  
 0x0=AC input relevant commands not supported  
 0x4=0.001  
 0x5=0.01  
 0x6=0.1  
 0x7=1.0  
 0x8=10  
 0x9=100

Bit 4:7 FAN\_SPEED Factor : The Factor of fan speed  
 0x0=Fan speed relevant commands not supported  
 0x4=0.001  
 0x5=0.01  
 0x6=0.1  
 0x7=1.0  
 0x8=10  
 0x9=100

byte2:

Bit 0:3 TEMPERATURE\_1 Factor : The Factor of internal ambient temperature  
 0x0=internal ambient temperature relevant commands not supported  
 0x4=0.001  
 0x5=0.01  
 0x6=0.1  
 0x7=1.0  
 0x8=10  
 0x9=100

Bit 4:7 CURVE\_TIMEOUT Factor : The Factor of CC/CV/Float timeout  
 0x0=CURVE\_TIMEOUT relevant commands not supported  
 0x4=0.001  
 0x5=0.01  
 0x6=0.1  
 0x7=1.0  
 0x8=10  
 0x9=100

©SYSTEM\_STATUS(0x00C1) :

	Bit7	Bit6	Bit5	Bit4	Bit3	Bit2	Bit1	Bit0
High byte	-	-	-	-	-	-	-	-
Low byte	-	EEPER	INITIA- LSTATE	ADL_ON	-	PFC_OK	DC_OK	M/S

Low byte

Bit 0: M/S : Parallel mode status  
 0 = Current device is Slave  
 1 = Current device is Master

Bit 1 DC\_OK : Secondary DD output voltage status  
 0 = Secondary DD output voltage status TOO LOW  
 1 = Secondary DD output voltage status NORMAL

Bit 2: PFC\_OK : Primary PFC status  
 0 = Primary PFC OFF or abnormal  
 1 = Primary PFC ON normally

Bit 4 ADL\_ON : Active dummy load control status  
 0 = Active dummy load off/function not supported  
 1 = Active dummy load on

Bit 5 INITIAL\_STATE : Device initialized status  
 0 = NOT in initialization status  
 1 = In initialization status

Bit 6 EEPER : EEPROM data access error  
 0 = EEPROM data access normal  
 1 = EEPROM data access error

Note: Unsupported settings displays with "0"

©SYSTEM\_CONFIG(0x00C2) :

	Bit7	Bit6	Bit5	Bit4	Bit3	Bit2	Bit1	Bit0
High byte	-	-	-	-	-	EEP_OFF	-	-
Low byte	-	-	-	-	-	OPERATION_INIT	CAN_CTRL	

Low byte:

Bit 0 CAN\_CTRL : CANBus communication control status

0 = The output voltage/current defined by control over SVR/PV/PC

1 = The output voltage, current, ON/OFF control defined by control over CANBus (VOUT\_SET, IOOUT\_SET, OPERATION)

Bit 1:2 OPERATION\_INIT : Pre-set value of power on operation command

0b00 = Power OFF, pre-set 0x00(OFF)

0b01 = Power ON, pre-set 0x01(ON)

0b10 = Pre-set is previous set value

0b11 = not used, reserved

High byte:

Bit 2 EEP\_OFF:EEPROM storage function ON/OFF

0: Enable. Parameters to be saved into EEPROM (factory default)

1: Disable. Parameters NOT to be saved into EEPROM

Note: Unsupported settings displays with "0"

### 6.2.3 Communication Examples

The following provides examples of command sending and data and reading for the CANBus protocol.

#### 6.2.3.1 Sending command

The master adjusts output voltage of the unit with address "01" to 30V.

CAN ID	DLC (data length)	Command code	Parameters
0x000C0101	0x4	0x2000	0x2C01

Command code: 0x0020 (VOUT\_SET) → 0x20(Lo) + 0x00(Hi)

Parameters: 30V → 300 → 0x012C → 0x2C(Lo) + 0x01(Hi)

NOTE: Conversion factor for VOUT\_SET is 0.1, so  $\frac{30V}{F=0.1} = 300$

#### 6.2.3.2 Reading data or status

The master reads operation setting from the unit with address "00".

CAN ID	DLC (data length)	Command code
0x000C0100	0x2	0x0000

The unit with address "00" returns data below

CAN ID	DLC (data length)	Command code	Parameters
0x000C0000	0x3	0x0000	0x01

Parameters: 0x01 ON, meaning that the unit with address "00" is operating.

### 6.2.4 Practical Operation of Charger Mode

The following steps will describe how to set the NCP-3200-48 to charger mode and adjust its curve for a 2-stage charging process, with a constant current (CC) of 50A and a constant voltage (CV) of 56V.

1. Set the ID of the rack supply to "0", by installing the rack supply in the far right slot or Module A and then setting the SWA DIP switch to ON/ON/ON/ON positions.

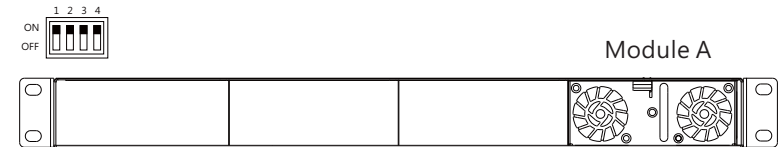

DHP-1UT-B

2. Connect the CANH/CANL pins of the master to the corresponding CANH (PIN6) and CANL (PIN7) pins of the JK1 connector on the rack shelf. It is recommended to establish a common ground for the communication system to increase its communication reliability by using GND-AUX (PIN8) of JK1.

©Set baud rate: 250kbps, type: extended

©Adding a 120Ω terminal resistor to both the controller and rack shelf ends can increase communication stability

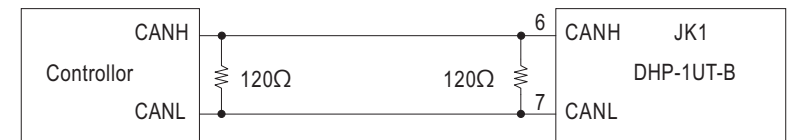

3. Configure communication settings after power on in remote off mode. Enable its charging functionality by setting the rack supply to charger mode and 2-stage charging mode.

CAN ID	DLC (data length)	Command Code	Parameters
0x000C0100	0x04	0xB400	0xC000

Command code: 0x00B4 (CURVE\_CONFIG) → 0xB4(Lo) + 0x00(Hi)

Parameters: C0(Lo) + 00(Hi). Please refer to definition of CURVE\_CONFIG for detailed information.

4. Set the constant current (CC) point to 50A

CAN ID	DLC(data length)	Command Code	Parameters
0x00C0100	0x04	0xB000	0xF401

Command code: 0x00B0(CURVE\_CC) → 0xB0(Lo) + 0x00(Hi)

Parameters: 50A → 500 → 0x01F4 → 0xF4(Lo) + 0x01(Hi)

NOTE: Conversion factor for CURVE\_CC is  $0.1 \cdot \text{so} \frac{56V}{F=0.1} = 560$

5. Set the constant voltage (CV) point to 56V

CAN ID	DLC(data length)	Command Code	Parameters
0x00C0100	0x04	0xB100	0x3002

Command code: 0x00B1(CURVE\_CV) → 0xB1(Lo) + 0x00(Hi)

Parameters: 56V → 560 → 0x0230 → 0x30(Lo) + 0x02(Hi)

NOTE: Conversion factor for CURVE\_CV is  $0.1 \cdot \text{so} \frac{56V}{F=0.1} = 560$

6. Before connecting to the batteries, it is recommended to review all of the settings and parameters using the appropriate commands. In the event that they do not meet your requirements, you may rewrite them as needed.

EX: Read CURVE\_CV to check whether CV level or Vboost was set to a proper level.

Read CURVE\_CV

CAN ID	LDC(data length)	Command Code
0x00C0100	0x2	0xB100

The unit returns data below

CAN ID	LDC(data length)	Command Code	Parameters
0x00C0000	0x4	0xB100	0x3002

Parameters: 0x30(Lo) + 0x02(Hi) → 0x0230 → 560 →  $560 \times 0.1(F) = 56V$

7. Finally, short circuit ON-OFF (PIN3) and +5-AUX (PIN21) pins of the CN1 connector on the rack shelf to remote on the supply to charge the batteries.

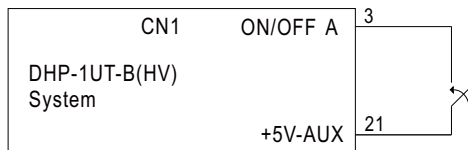

## 6.3 Value Range and Tolerance

(1) Display parameters

Command Name	Model	Display value range	Tolerance
READ_VIN	ALL	80~264V	±10V
READ_VOUT	24V	0~30V	±0.36V
	48V	0~60V	±0.48V
	380V	0~400V	±3.8V
READ_IOUT (Note. ii)	24V	0~160A	±5.32A
	48V	0~80A	±2.68A
	380V	0~12A	±0.5A
READ_TEMPERATURE_1	ALL	-40~110°C	±5°C

Table 6-3

(2) Control parameters

Command Name	Model	Adjustable range	Tolerance	Default
OPERATION	ALL	PM: 00h(OFF)/80h(ON) CAN: 00h(OFF)/01h(ON)	N/A	ON
VOUT_COMMAND (PMBus only)	24V	24V	N/A	24V
	48V	48V	N/A	48V
	380V	380V	N/A	380V
VOUT_TRIM (PMBus only)	24V	-12 ~ 6V	±0.36V	24V
	48V	-24 ~ 12V	±0.48V	48V
	380V	-213 ~ 20V	±3.8V	380V
VOUT_SET (CANBus only)	24V	12 ~ 30V	±0.36V	24V
	48V	24 ~ 60V	±0.48V	48V
	380V	167 ~ 400V	±3.8V	380V
IOUT_OC_FALUT_ LIMIT(PM) and IOUT_SET(CAN)	24V	26.75~146.25A	±5.32A	146.25A
	48V	13.5~73.5A	±2.68A	73.5A
	380V	1.9~10.6A	±0.5A	9.6A

Table 6-4

Command Name	Model	Adjustable range	Tolerance	Default
CURVE_VBST	24V	18~30V	±0.36V	28.8V
	48V	36~60V	±0.48V	57.6V
CURVE_VFLOAT	24V	18~VBST	±0.36V	27.6V
	48V	36~VBST	±0.48V	55.2V
CURVE_ICHG	24V	22~110A	±5.32A	110A
	48V	11~55A	±2.68A	55A
CURVE_ITAPER	24V	5.5~33A	±5.32A	11A
	48V	3~16.5A	±2.68A	5.5A
CURVE_CONFIG	24V	N/A	N/A	0004h
	48V			
CURVE_CC_TIMEOUT	24V 48V	60~64800 minute	±5 minute	600 minute
CURVE_CV_TIMEOUT				
CURVE_FLOAT_TIMEOUT				
SYSTEM_CONFIG	ALL	N/A	N/A	02h

Note:

i.READ\_IOUT will display ZERO amp when output current is less than values in the table below.

Model	Minimum readable current
24V	5.3A±1A
48V	2.7A±1A
380V	0.4A±1A

ii. Due to the limited write cycles of the EEPROM, it is advisable to consider using the SYSTEM\_CONFIG (PM: BEh; CAN: 0x00C2) command to select an appropriate EEPROM writing logic, especially if communication settings are frequently altered.

iii.Changing parameters to CUVE (Low byte: Bit 7) of CURVE\_CONFIG command requires a reboot to take effect.

## 7. Protections and Trouble Shooting

### 7.1 Over Temperature Protection (OTP) and T Alarm

- Built-in 2 sets of thermal detection circuit, once the internal temperature exceeds a threshold value, the supply will shut down automatically while the fans are still running. Please switch off the supply, remove all possible causes and allow the supply cooling down to a normal working temperature (approximate 10 minutes – 1 hour) before repower on again.
- When the internal temperature reaches 60°C, which is the trigger point for the thermal alarm, the LED indicator on the front panel will flash in red and there will be alarm data that can be read through the communication interface (refer to chapter 6). However, the units will continue to operate normally.
- Built-in fan-lock protection circuit, the supply will shut the output off when the DC fans stop operating due to fan-lock or broken wires. In the meantime, a "High" signal will be sent out through T-ALARM, referenced to GND AUX. Please remove the unit from your system and send it back to our local distributor or MEAN WELL for repair.
- Maximum output current: 10mA.
- The fans are designed to stop themselves in low ambient temperature condition to prolong the lifespan. Fan lock protection mechanism is only activated when the fan speed and ambient temperature exceed a certain value.

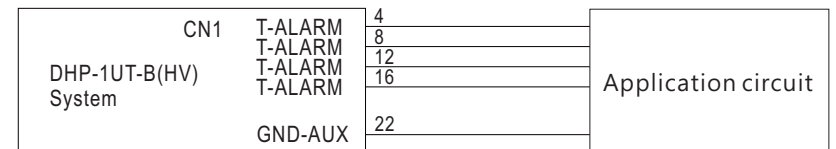

Figure 7-1

T-ALARM signal	Condition
"Low" < -0.5~0.5V	Internal temp. within a normal range and fan working normally
"High" > 3.5~5.5V	Internal temp. abnormal or fan lock

## 7.2 Short-Circuit and Over Load Protection

- When the load current exceeds  $110\% \pm 5\%$  of the rated current, protection mode will be triggered. Repower on to restore after overcurrent condition is resolved.

## 7.3 Over Voltage Protection

- Built-in over voltage protection circuit for every single units.
- OVP triggering points vary in different output models. Please refer to the specification sheet for detailed information.
- Once OVP is triggered, leave the units off for 10 seconds before recycling AC again.

## 7.4 Trouble Shooting

Failure Stage	Possible Cause	Suggested Solution
The supply or charger is not working	Remote OFF	Make sure remote ON-OFF is connected to +5V-AUX
Battery cannot be fully charged	Battery aged or malfunction	Replace a new battery
	Small cross-section of cable	Choose a proper cable for use
	Wrong charging curve	Double check the characteristic of battery
LED indicator showed abnormal situation	Over temperature	Re-power on the unit after ambient temperature dropped down to a normal level
	Battery's BMS Causing malfunction of charger	Please contact battery's manufacturer for details
	Battery voltage not match	Please check the specification of battery for matching
	Abnormal battery detected	Please ensure that the status of the battery is normal

If you are unable to clarify the problem you are facing, please contact MEAN WELL or any of our distributors for repair service.

## 8.Warranty



This product provides a five-year warranty under normal use. In order to keep the warranty valid, do not replace any parts or modify the product in any way.



- ※ MEAN WELL possesses the right to adjust the content of this manual. Please refer to the latest version of manual on our website. <https://www.meanwell.com>

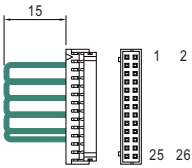
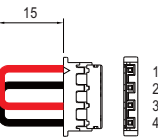

# A.Appendix

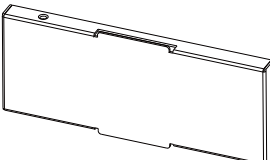
## Accessory List

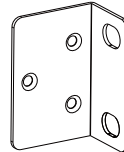
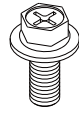
	Item	Quantity
①	Remote Control mating wire (CN1) UL1061 28AWG 	1
②	Remote Sense mating wire (CN2) UL1007 26AWG 	1
③	PMBus Termination resistor (JK1) Wire color : Black & White 	1
④	CANBus Termination resistor (JK1) Wire color : Black & Red 	1
⑤	Blank panel for empty slot 	3

	Item	Quantity
⑥	Rack mount bracket 	2
⑦	Screw (+V,-V Terminal) 	4
⑧	Screw 3*4mm (Blank panel for empty slot) 	6
⑨	Screw 4*5mm (Rack mount bracket) 	6

明緯企業股份有限公司

MEAN WELL ENTERPRISES CO., LTD.

248 新北市五股區五權三路28號

No.28, Wuquan 3rd Rd., Wugu Dist., New Taipei City 248, Taiwan

Tel:886-2-2299-6100 Fax:886-2-2299-6200

<http://www.meanwell.com> E-mail:[info@meanwell.com](mailto:info@meanwell.com)