

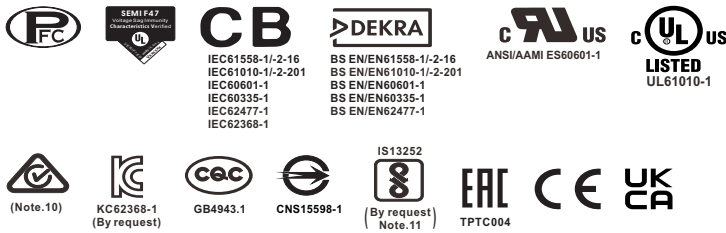

Front



Back



### Features

- 85~264Vac input with PFC
- Global certificates in multi-fields(Medical 60601-1, Household 60335-1, Industrial 61558-1/-2-16/61010-1, Energy converter 62477-1)
- High efficiency up to 92%
- Output voltage 15 ~115% programmable
- Built-in CANBus protocol
- -40~+85°C wide range operation temperature
- Extremely low leakage current <500µA, 2 x MOPP, suitable for BF medical applications
- Protections: Short circuit / Overload / Over voltage / Over temperature
- Built-in Remote ON/OFF control / Remote Sense / DC OK signal / OTP alarm signal /12Vaux power
- Over voltage category III (OVC III)
- Operating altitude up to 5000 meters
- Built-in intelligent fan speed control, low noise <39dB
- Conformal coating
- 5 years warranty

### Description

The MSP-1600 series is a 1600W AC/DC power supply with PFC function, designed for high reliability and suitable for multiple industries. Key features include: compact size (310\*85\*41mm) for better space utilization in system installations, ultra-wide input range of 85~264Vac for global compatibility, up to 92% efficiency, programmable output voltage (15~115%), built-in CANBus communication interface, wide operating temperature range from -40 to +85°C (+50°C at full load), compliance with OVCIII, built-in Remote Control /Remote Sense/DC OK signal/auxiliary power, internal PCB coating, complete protections, certifications for multiple safety standards including 60601-1, 61558-1, 60335-1, 62477-1, and 61010-1, as well as 2 X MOPP compliance and extremely low leakage current (<500µA). It is suitable for BF-rated medical equipment and comes with a 5-years warranty, making it a highly cost-effective solution for industrial power supply needs.

### Model Encoding

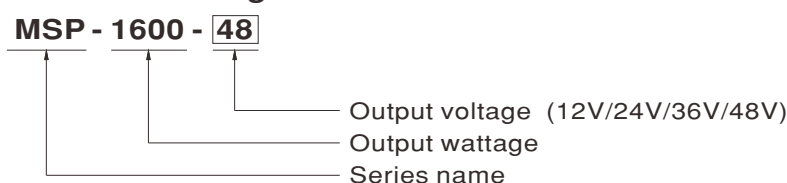

### Applications

- Industrial automation machinery/ control system
- Security system
- Mechanical and electrical equipment
- Electronic instruments, equipments or apparatus
- Network equipment
- Telecom devices
- Power sourcing equipment of PoE
- Home automation
- Medical devices
- Supercapacitor

### GTIN CODE

MW Search: <https://www.meanwell.com/serviceGTIN.aspx>



1600W AC/DC High Reliable Multi-Industries Enclosed Type Power Supply **MSP-1600** series

SPECIFICATION	MSP-1600-12	MSP-1600-24	MSP-1600-36	MSP-1600-48
<b>OUTPUT</b>				
DC VOLTAGE	12V	24V	36V	48V
RATED CURRENT	125A	67A	44.5A	33.5A
CURRENT RANGE	0 ~ 125A	0 ~ 67A	0 ~ 44.5A	0 ~ 33.5A
RATED POWER	1500W	1608W	1602W	1608W
RIPPLE & NOISE (max.)	Note.2 150mVp-p	200mVp-p	250mVp-p	300mVp-p
VOLTAGE ADJ. RANGE	11.5 ~ 14V	23.5 ~ 28V	35.5 ~ 42V	47.5 ~ 56V
VOLTAGE TOLERANCE	Note.3 ±1.0%	±1.0%	±1.0%	±1.0%
LINE REGULATION	±0.5%	±0.5%	±0.5%	±0.5%
LOAD REGULATION	±0.5%	±0.5%	±0.5%	±0.5%
SETUP, RISE TIME	1500ms, 60ms/230Vac at full load			
HOLD UP TIME (Typ.)	16ms / 230Vac at 70% load	10ms / 230Vac at full load		
<b>INPUT</b>				
VOLTAGE RANGE	Note.4 85 ~ 264Vac	250 ~ 400Vdc		
FREQUENCY RANGE	47 ~ 63Hz			
POWER FACTOR (Typ.)	0.97/230Vac at full load			
EFFICIENCY (Typ.)	88.5%	90.5%	91%	92%
AC CURRENT (Typ.)	Note.4 14A/115Vac	8A/230Vac	15A/115Vac	8.5A/230Vac
INRUSH CURRENT (Typ.)	COLD START 60A/230Vac			
LEAKAGE CURRENT	Earth leakage current <500µA(rms)/264Vac ; Touch current<100µA(rms)/264Vac			
<b>PROTECTION</b>				
OVERLOAD	105 ~ 115% rated output power			
	Protection type : Constant current limiting, unit will shut down o/p voltage after 5 sec. After O/P voltage falls, re-power on to recover			
OVER VOLTAGE	15.75 ~ 18.75V	31.5 ~ 37.5V	47.2 ~ 56.3V	56 ~ 60V
	Protection type : Shut down o/p voltage, re-power on to recover			
OVER TEMPERATURE	Shut down o/p voltage, recovers automatically after temperature goes down			
<b>FUNCTION</b>				
OUTPUT VOLTAGE PROGRAMMABLE(PV)	Adjustment of output voltage is allowable to 15 ~ 115% of nominal output voltage Please refer to the Function Manual.			
REMOTE CONTROL	By electrical signal or dry contact Power ON:short Power OFF:open. Please refer to the Function Manual			
REMOTE SENSE	Compensate voltage drop on the load wiring up to 0.5Vdc. Please refer to the Function Manual			
AUXILIARY POWER	12Vaux @ 0.8A, tolerance: 10.6~13.2V; Ripple: 450mV			
DC OK SIGNAL	Contact rating(max.):5Vdc/10mA resistive load			
CANBus(Built-in)	Communication provides functions such as control, setting and monitoring			
FAN SPEED CONTROL(Typ.)	Note.7	Built-in intelligent fan speed control detect by PSU'S internal temperature		
	10% load with Ta=25°C	39dB	39dB	39dB
	70% load with Ta=25°C	43dB	39dB	39dB
<b>ENVIRONMENT</b>				
WORKING TEMP.	-40 ~ +85°C (Refer to "Derating Curve")			
WORKING HUMIDITY	20 ~ 90% RH non-condensing			
STORAGE TEMP., HUMIDITY	-40 ~ +85°C, 10 ~ 95% RH non-condensing			
TEMP. COEFFICIENT	±0.03%/°C (0 ~ 50°C)			
VIBRATION	10 ~ 500Hz, 2G 10min./1cycle, 60min. each along X, Y, Z axes			

SAFETY & EMC (Note.8)				
SAFETY STANDARDS	CB	IEC60335-1, IEC61558-1/-2-16, IEC61010-1/-2-201, IEC60601-1(3.2 version); IEC62477-1, IEC62368-1		
	DEKRA	BS EN/EN60601-1, BS EN/EN60335-1, BS EN/EN61558-1/-2-16, BS EN/EN61010-1/-2-201, BS EN/EN62477-1		
	UL	ANSI/AAMI ES60601-1(3.2 Version), UL61010-1/-2-201		
	CQC	GB4943.1		
	BSMI	CNS15598-1		
	EAC	TP TC 004		
		SEMI F47 approved		
	KC/BIS	KC 62368-1 and BIS IS 13252(Part 1) certified, no stock by request, contact sales for inquires		
ISOLATION LEVEL	Primary-Secondary: 2xMOPP, Primary-Earth: 1xMOPP, Secondary-Earth: 1xMOPP			
OVER VOLTAGE CATEGORY	IEC/EN 61558-1/-2-16	(OVC III, altitude up to 2000M)		
	IEC 62368-1	(OVC II, altitude up to 5000M)		
	IEC/EN 60335-1	(OVC II, altitude up to 5000M)		
	IEC/EN/ANSI/AAMI ES60601-1	(OVC II, altitude up to 4000M)		
	IEC/EN/UL 61010-1/-2-201	(OVC II, altitude up to 5000M)		
	IEC/EN 62477-1	(OVC II, altitude up to 5000M)		
SAFETY EXTRA-LOW VOLTAGE(SELV)	IEC/EN 61558-2-16 (SELV, 12 ~ 48V)			
	IEC/EN 60335-1 (SELV, 12 ~ 36V)			
	IEC 62368-1 (SELV/ES1, 12 ~ 48V)			
WITHSTAND VOLTAGE	I/P-O/P:4.2KVac	I/P-FG:2.1KVac	O/P-FG:1.5KVac	
ISOLATION RESISTANCE	I/P-O/P, I/P-FG, O/P-FG:100M Ohms / 500Vdc / 25°C / 70% RH			
EMC EMISSION	Conducted	Parameter	Standard	Test Level / Note
			BS EN/EN55032(CISPR32), CNS 15936, GB/T 9254.1, KS C 9832	Class B
	Radiated		BS EN/EN55014-1(CISPR14-1)	-----
			BS EN/EN55011(CISPR11)	Class B
			BS EN/EN55032(CISPR32), CNS 15936, GB/T 9254.1, KS C 9832	Class B
	Harmonic Current		BS EN/EN61000-3-2(IEC61000-3-2)	Class A
			BS EN/EN61000-3-3(IEC61000-3-3)	-----
	EMC IMMUNITY	BS EN/EN55035(CISPR35), BS EN/EN61000-6-2(IEC61000-6-2), BS EN/EN60601-1-2(IEC60601-1-2), BS EN/EN55014-2(CISPR14-2), KS C 9835, SEMI F47 tested at 200Vac		
Parameter		Standard	Test Level / Note	
ESD		BS EN/EN61000-4-2	Level 4, 15KV air ; Level 4, 8KV contact	
Radiated		BS EN/EN61000-4-3	Level 3, 10V/m(80MHz~2.7GHz) Table 9, 9~28V/m(385MHz~5.78GHz)	
EFT / Burst		BS EN/EN61000-4-4	Level 3, 2KV	
Surge		BS EN/EN61000-4-5	Level 4, 2KV/Line-Line 4KV/Line-Earth	
Conducted		BS EN/EN61000-4-6	Level 3, 10V	
Magnetic Field		BS EN/EN61000-4-8	Level 4, 30A/m	
Voltage Dips and Interruptions	BS EN/EN61000-4-11	>95% dip 0.5 periods, 30% dip 25 periods, >95% interruptions 250 periods		
OTHERS				
MTBF	653.8K hrs min. Telcordia SR-332 (Bellcore) ; 65.3K hrs min. MIL-HDBK-217F (25°C)			
DIMENSION	310*85*41mm (L*W*H)			
PACKING	1.72Kg;6pcs/11.3Kg/1.28CUFT			
NOTE				
1. All parameters NOT specially mentioned are measured at 230Vac input, rated load and 25°C of ambient temperature. 2. Ripple & noise are measured at 20MHz of bandwidth by using a 12" twisted pair-wire terminated with a 0.1uf & 47uf parallel capacitor. 3. Tolerance : includes set up tolerance, line regulation and load regulation. 4. Derating may be needed under low input voltages. Please check the derating curve for more details. 5. If use PV signal to adjust Vo, under certain operation conditions, ripple noise of Vo might go over rating defined in this specification. 6. Length of set up time is measured at first cold start. Turning ON/OFF the power supply may lead to increase of the set up time. 7. FAN noise test set up according to ISO-7779. 8. The power supply is considered a component which will be installed into a final equipment. All the EMC tests are been executed by mounting the unit on a 720mm*360mm metal plate with 1mm of thickness. The final equipment must be re-confirmed that it still meets EMC directives. For guidance on how to perform these EMC tests, please refer to "EMI testing of component power supplies." (as available on <a href="https://www.meanwell.com/Upload/PDF/EMI_statement_en.pdf">https://www.meanwell.com/Upload/PDF/EMI_statement_en.pdf</a> ) 9. The ambient temperature derating of 3.5°C/1000m with fanless models and of 5°C/1000m with fan models for operating altitude higher than 2000m(6500ft). 10. The Regulatory Compliance Mark (RCM) is applied on a voluntary basis. The equipment meets the relevant IEC or AS/NZS standards, or AS/NZS 3820 where applicable. The use of the RCM mark complies with AS/NZS 4417.1. 11. Some factory or model may not have the BIS logo, please contact your MEAN WELL sales for more information. ※ Product Liability Disclaimer : For detailed information, please refer to <a href="https://www.meanwell.com/serviceDisclaimer.aspx">https://www.meanwell.com/serviceDisclaimer.aspx</a>				

**Block Diagram**

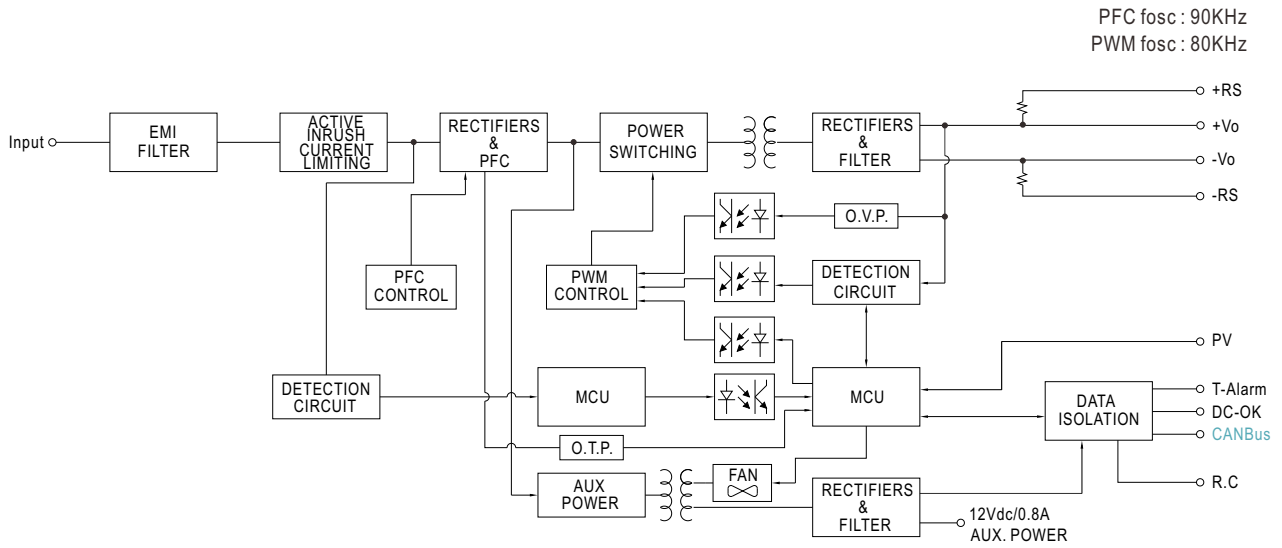

**Static Characteristics**

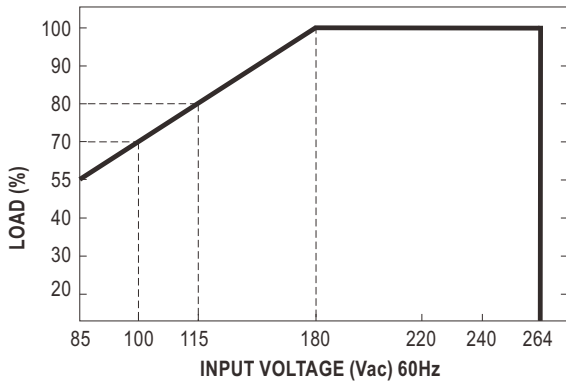

INPUT \ MODEL	12V	24V	36V	48V
180~264Vac	1500W 125A	1608W 67A	1602W 44.5A	1608W 33.5A
115Vac	1200W 100A	1286W 53.6A	1282W 35.6A	1286W 26.8A
100Vac	1050W 87.5A	1126W 46.9A	1121W 31.15A	1126W 23.45A
85Vac	826W 68.8A	888W 37A	882W 24.5A	888W 18.5A

**Derating Curve**

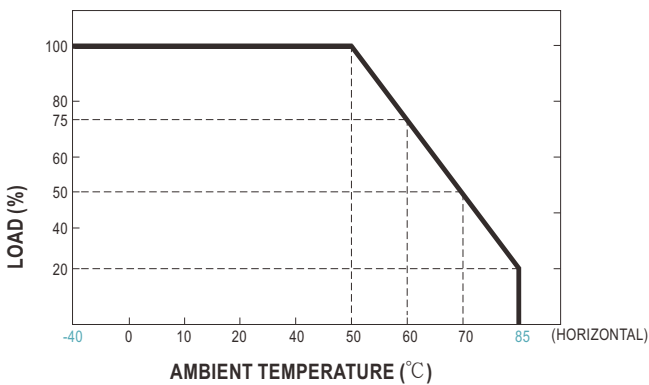

**Efficiency vs Load (48V Model)**

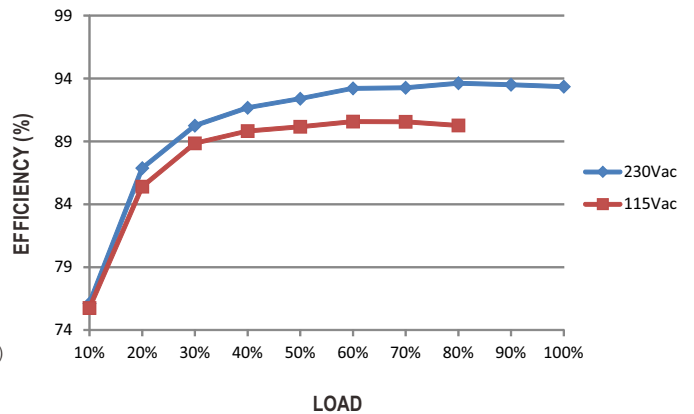

© The curve above is measured at 115/230Vac.

■ **Function Manual**

**1. Output Voltage Programming (P.V)**

※ In addition to the adjustment via the built-in potentiometer, the output voltage can be trimmed by applying External Voltage.

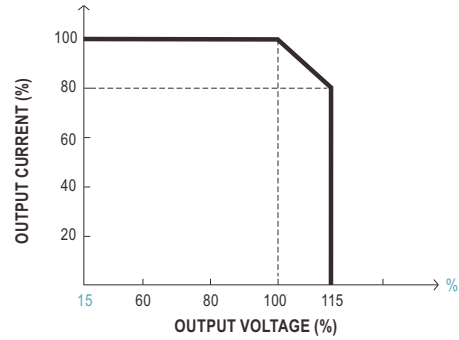
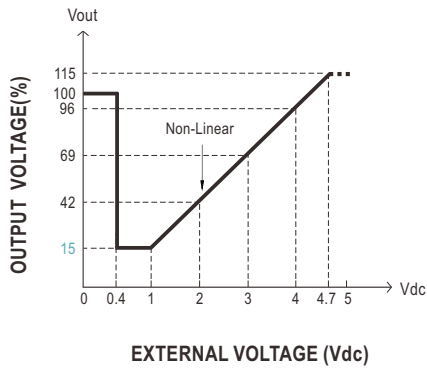
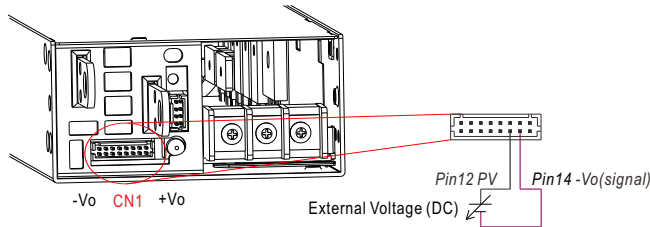

- ◎ The rated current should change with the Output Voltage Programming accordingly.
- ◎ For Remote Sense / Local Sense, please refer to "Voltage Drop Compensation" section.

**2. Remote Control**

※ The power supply can be turned ON/OFF individually or along with other units by using the "Remote Control" function.

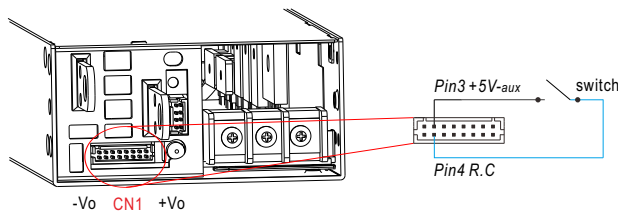

PSU Vo Status	Between +5V-aux(Pin 3) and R.C(Pin 4)
Power ON	Switch Short
Power OFF	Switch Open

R.C. by external switch.	R.C. by user's optocoupler control module.	R.C. by user's Relay control module.

### 3. Remote Sense

※ The Remote Sense compensates voltage drop on the load wiring up to 0.5Vdc

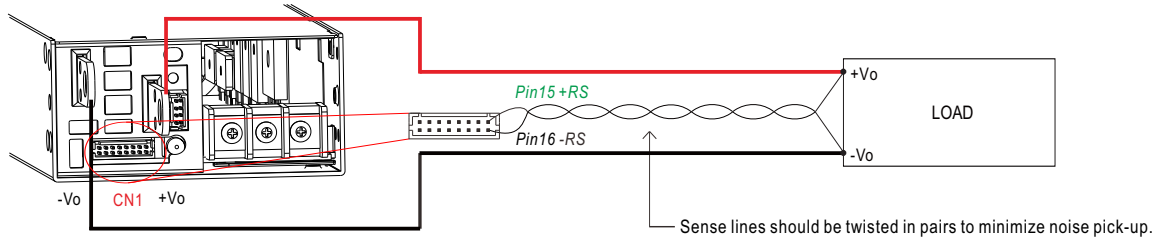

◎ The +RS signal should be connected to the positive terminal of the load whereas -RS signal to the negative terminal.

### 4. Local Sense

※ The +RS, -RS have to be connected to the +Vo(signal), -Vo(signal), respectively, as the following diagram, in order to get the correct output voltage if Remote Sense is not used.

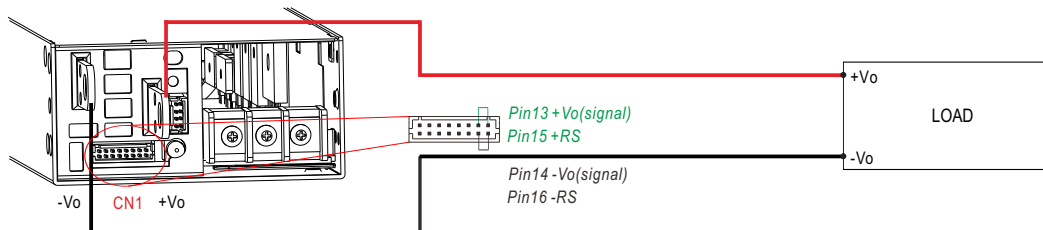

### 5. DC OK Signal

※ There are 2 alarm signals, DC OK and T-ALARM, in TTL signal form, on CN1. These signals are isolated from output. The maximum sink current is 10mA.

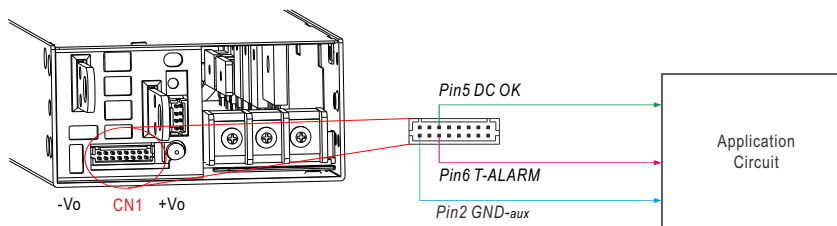

DC OK Fail signal	Power Supply Status
"High" > 3.5~5.5V	Vout ≅ 77%±5%
"Low" < -0.5~0.5V	Vout ≅ 80%±5%

T-ALARM	Power Supply Status
"High" > 3.5~5.5V	OFF(OTP or Fan Fail)
"Low" < -0.5~0.5V	ON(Normal Work)

### 6. Support CANBus(Built-in) Communication

※ Communication provides function such as control, setting and monitorin , Parameters include output power, input voltage,ect.

For more details, please refer to: <http://www.meanwell.com/manual.html>

Case No.296A

**Mechanical Specification**

(Unit: mm , tolerance ±0.5mm)

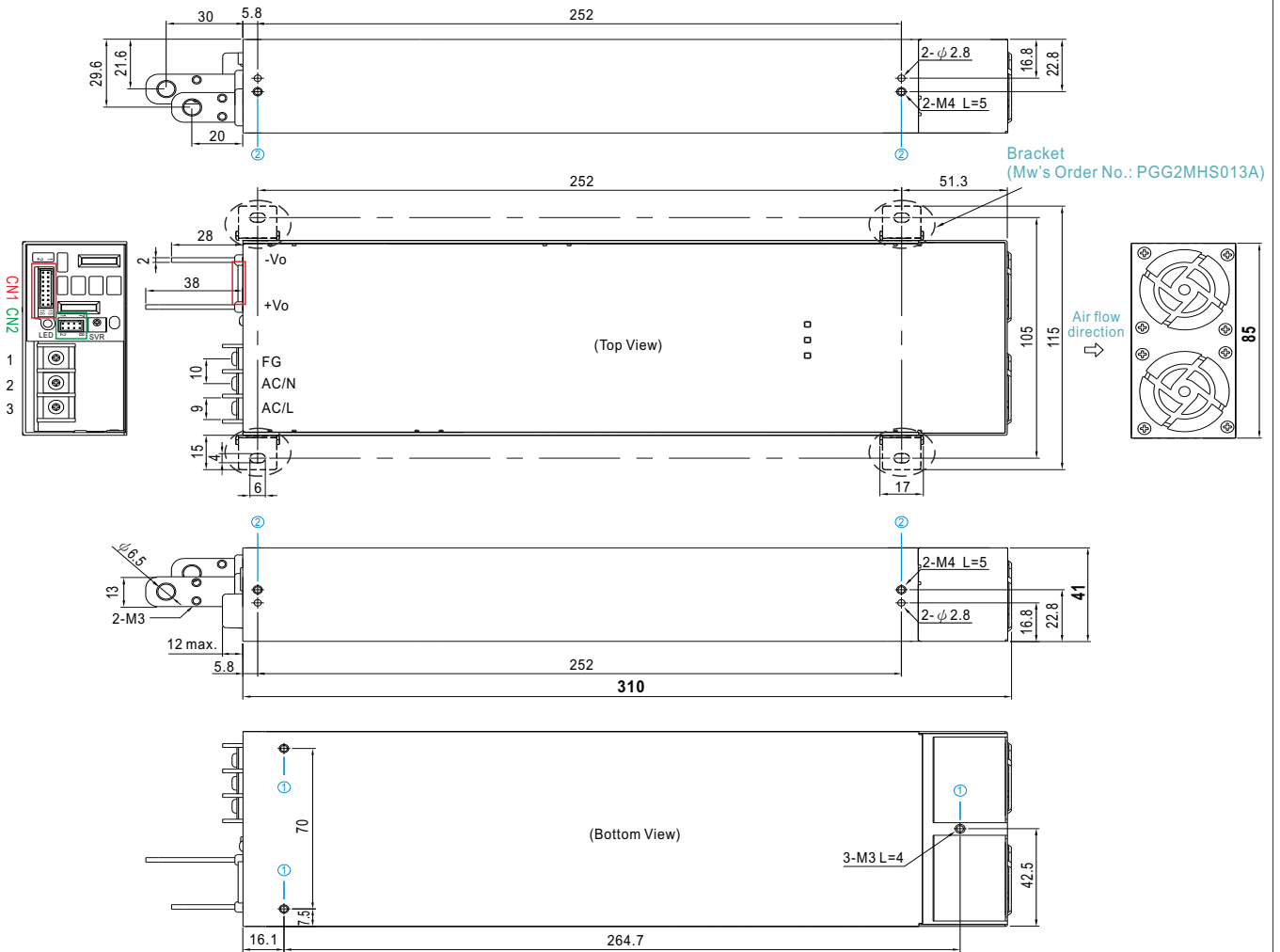

※ Mounting Instruction

Hole No.	Recommended Screw Size	MAX. Penetration Depth L	Recommended mounting torque
①	M3	4mm	6~8Kgf-cm
②	M4	5mm	7~10Kgf-cm

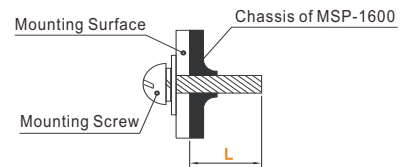

※ Control Pin No. Assignment(CN1) : HRS DF11-16DP-2DS or equivalent

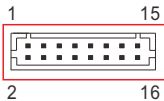











Mating Housing	HRS DF11-16DS or equivalent
Terminal	HRS DF11-16SC or equivalent

Pin No.	Function	Description
1	+12V-aux	Auxiliary voltage output, 10.6~13.2Vdc, referenced to GND-aux (pin2). The maximum load current is 0.8A. This output has the built-in "Oring diodes" and is not controlled by "Remote ON-OFF".
2	GND-aux	Auxiliary voltage output GND. The signal return is isolated from the output terminals (+Vo & -Vo).
3	+5V-aux	This pin is use for remote ON-OFF usage only.
4	R.C	The unit can turn the output ON/OFF by electrical signal or dry contact between <i>Remote ON/OFF</i> and +5V-aux. (Note.2) Short (4.5 ~ 5.5Vdc) : Power ON ; Open (-0.5 ~ 0.5Vdc) : Power OFF ; The maximum input voltage is 5.5Vdc.
5	DC-OK	High (3.5 ~ 5.5Vdc) : When the $V_{out} \leq 77\% \pm 5\%$ . Low (-0.5 ~ 0.5Vdc) : When $V_{out} \geq 80\% \pm 5\%$ . The maximum sourcing current is 10mA and only for output. (Note.2)
6	T-ALARM	High (3.5 ~ 5.5Vdc) : When the internal temperature exceeds the limit of temperature alarm, or when Fan fails. Low (-0.5 ~ 0.5Vdc) : When the internal temperature is normal, and when Fan works normally. The maximum sourcing current is 10mA and only for output(Note.2)
7,8,9	A0,A1,A2	CANBus interface address lines. (Note.1)
10,11	NC	Retain for future use.
12	PV	Connection for output voltage programming. (Note.1)
13	+Vo(Signal)	Positive output voltage signal. It is for local sense; it cannot be connected directly to the load.
14	-Vo(Signal)	Negative output voltage signal. It is for local sense and certain function reference; it cannot be connected directly to the load.
15	+RS	Positive sensing for remote sense.
16	-RS	Negative sensing for remote sense.

Note1: Non-isolated signal, referenced to [-Vo(signal)].

Note2: Isolated signal, referenced to [GND-aux].

※ LED Status Indicators

Description	Output of alarm
Overload	Red : 1 Blink/Pause  
Over voltage	Red : 2 Blink/Pause  
Over temperature	Red : 3 Blink/Pause  
Fan fail	Red : 4 Blink/Pause  
Others (Note)	Red : 5 Blink/Pause  

Note: Others include protection status SCP、AC UVP and EEPROM error.

※ AC Input Terminal Pin No. Assignment

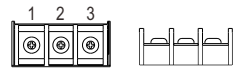
Pin No.	Assignment	Diagram	Screw thread	Maximum mounting torque
1	FG $\perp$		M3.5	8Kgf-cm
2	AC/N			
3	AC/L			

※ Control Pin No. Assignment(CN2) : HRS DF11-8DP-2DS or equivalent

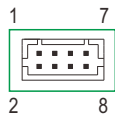

Mating Housing	HRS DF11-8DS or equivalent
Terminal	HRS DF11-**SC or equivalent

Pin No.	Function	Description
1,2,3,4	NC	For standard model: Retain for future use.
5,6	-Vo (Signal)	Negative output voltage signal. It is for local sense and certain function reference; it cannot be connected directly to the load.
7	CANH	For CANBus model: Data line used in CANBus interface. (Note)
8	CANL	For CANBus model: Data line used in CANBus interface. (Note)

Note: Isolated signal, referenced to [GND-aux].

### ■ Accessory List

No.	Item	Quantity
1	Control function interface(CN1) mating wire along with MSP-1600 (standard accessory)	1pcs/per model
2	Bracket Mw's Order No.: PGG2MHS013A (By request accessory, should ordered seperately)	4pcs/per model (Please refer to Installation Diagram)
3	Terminal cover MW'S Order NO. :PEE4TBC-03-DG (By request accessory,should ordered seperately)	1pcs/per model

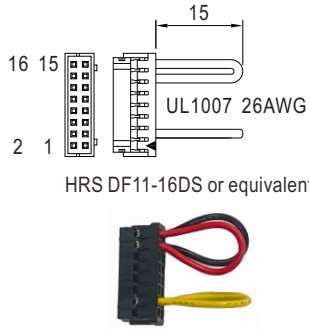

### ■ Installation Diagram

